



Tailing Electronics

产品手册

PRODUCT
MANUAL

—专注于 OLED/LCD 的生产制造—

-Focusing on the production and manufacturing of OLED /LCD /TFT -

Display Module

OLED/LCD/Electronic Paper/Character Screen

PRODUCTION **MANUFACTURING**

Telephone +86 136 2249 6694

Email tech@ tonglispring



Website <https://tonglispring.com/>

OLED单色裸屏 Monochrome OLED Screen

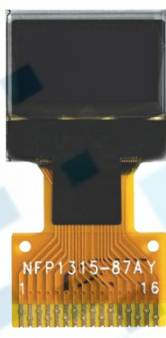
0.32 ~0.50 inch

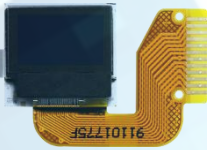
尺寸 Size		0.32 inch		0.42 inch
分辨率 Number of Pixels		60x32		72x40
驱动 Driver IC		SSD1315		SSD1315
显示区域 Active Area		7.06x3.82mm		9.196x5.18mm
面板尺寸 Panel Size		9.96x 8.85x1.2mm		12x11x1.25mm
颜色 Color		Monochrome(White)		Monochrome(White)
接口 Interface		IIC		4-SPI/IIC
管脚 Pin		14pins 0.62 mm pitch		16pins 0.65 mm pitch
供电方式 Driving Power	Internal DC/DC	3.3-4.2V	Internal DC/DC	3.3-4.2V
	Supplied Externally	9V	Supplied Externally	9V



尺寸 Size		0.42 inch		0.42 inch
分辨率 Number of Pixels		72x40		72x40
驱动 Driver IC		SSD1315		SSD1306
显示区域 Active Area		9.196x5.18mm		9.196x5.18mm
面板尺寸 Panel Size		12x11x1.25mm		14.9x11x1.25mm
颜色 Color		Monochrome(White)		Monochrome(White)
接口 Interface		IIC		IIC
管脚 Pin		16pins 0.5 mm pitch		12pins 0.7 mm pitch
供电方式 Driving Power	Internal DC/DC	3.3-4.2V	Internal DC/DC	3.3-4.2V
	Supplied Externally	9V	Supplied Externally	9V



尺寸 Size		0.49 inch		0.49 inch
分辨率 Number of Pixels		64x32		64x32
驱动 Driver IC		SSD1315		SSD1315
显示区域 Active Area		11.18x5.58mm		11.18x5.58mm
面板尺寸 Panel Size		14.5x11.6x1.227mm		14.5x11.6x1.227 mm
颜色 Color		Monochrome(White)		Monochrome(White)
接口 Interface		IIC		IIC
管脚 Pin		14pins 0.7 mm pitch		14pins 0.5 mm pitch
供电方式 Driving Power	Internal DC/DC	3.3-4.2V	Internal DC/DC	3.3-4.2V
	Supplied Externally	7.25V	Supplied Externally	7.25V



尺寸 Size		0.49 inch		0.5 inch
分辨率 Number of Pixels		64x32		88X48
驱动 Driver IC		SSD1315		CH1115
显示区域 Active Area		7.06x3.82(mm)		6.124 x 11.244 (mm)
面板尺寸 Panel Size		9.96x 8.85x1.2 (mm)		8.928x17.1x1.227
颜色 Color		Monochrome(White)		Monochrome(White)
接口 Interface		IIC		IIC
管脚 Pin		14pins 0.7 mm pitch		14pins 0.62 mm pitch
供电方式 Driving Power	Internal DC/DC	3.3-4.2V	Internal DC/DC	3.3-4.2V
	Supplied Externally	7.25V	Supplied Externally	7.25V



OLED单色裸屏 Monochrome OLED Screen

0.54~0.66 inch

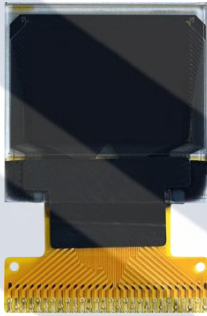
Size		0.54 inch		0.63 inch
Number of Pixels		96x32		120x28
Driver IC		CH1115		SSD1312
Active Area		12.46x4.14 mm		15.58 x 3.62mm
Panel Size		18.52x7.04x1.22mm		21.54 x 6.62x1.22 mm
Color		Monochrome(White)		Monochrome(White)
Interface		IIC		IIC
Pin	14pins 0.62mm pitch	14pins 0.62mm pitch		
Driving Power	Internal DC/DC	3.3-4.2V	Internal DC/DC	3.3-4.2V
	Supplied Externally	8V	Supplied Externally	8V

Size		0.66 inch		0.66 inch
分辨率 Number of Pixels		64x48		64x48
驱动 Driver IC		SSD1315 兼容 SSD1306		SSD1315 兼容 SSD1306
显示区域 Active Area		13.42x10.06mm		13.42x10.06mm
面板尺寸 Panel Size		16.42x16.9x1.25mm		18.46x18.1x1.25mm
颜色 Color		Monochrome(White)		Monochrome(White)
接口 Interface		4-SPI,IIC,8-bit 68XX/80XX		4-SPI,IIC,8-bit 68XX/80XX
管脚 Pin	28pins 0.65mm pitch	28pins 0.65mm pitch		
供电方式 Driving Power	Internal DC/DC	3.3-4.2V	Internal DC/DC	3.3-4.2V
	Supplied Externally	7.5V	Supplied Externally	9V



尺寸 Size		0.66 inch		0.66 inch
分辨率 Number of Pixels		64x48		64x48
驱动 Driver IC		SSD1306		SSD1306
显示区域 Active Area		13.42x10.06mm		13.42x10.06mm
面板尺寸 Panel Size		18.46x18.1x1.45mm		18.46x18.1x1.4mm
颜色 Color		(White/Blue)		Monochrome(White)
接口 Interface		4-SPI,IIC,8-bit 68XX/80XX		4-SPI
管脚 Pin	28pins 0.65mm pitch	16pins 0.65 mm pitch		
供电方式 Driving Power	Internal DC/DC	3.3-4.2V	Internal DC/DC	3.3-4.2V
	Supplied Externally	7.25V	Supplied Externally	7.5V

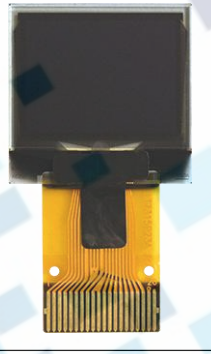

尺寸 Size		0.66 inch		0.66 inch
分辨率 Number of Pixels		64x48		64x48
驱动 Driver IC		SSD1306		SSD1315
显示区域 Active Area		13.42x10.06mm		13.42x10.06mm
面板尺寸 Panel Size		18.46x18.1x1.23mm		18.46x18.1x1.25mm
颜色 Color		Monochrome(White)		Monochrome(White)
接口 Interface		4-SPI		4-SPI
管脚 Pin	20pins 0.5 mm pitch	16pins 0.5 mm pitch		
供电方式 Driving Power	Internal DC/DC	3.3-4.2V	Internal DC/DC	3.3-4.2V
	Supplied Externally	7.5V	Supplied Externally	9.0V

OLED单色裸屏 Monochrome OLED Screen

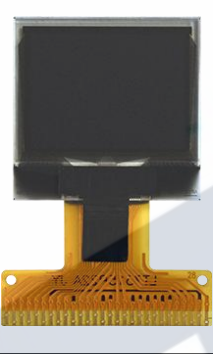
0.66~0.72 inch

尺寸 Size		0.66 inch		0.66 inch
分辨率 Number of Pixels		64x48		64x48
驱动 Driver IC		ST7315P17		ST7315P17
显示区域 Active Area		10.06x13.42mm		10.06x13.42mm
面板尺寸 Panel Size		16.5 x16.2x 1.23mm		16.5 x16.2x 1.23mm
颜色 Color		Monochrome(White)		Monochrome(White)
接口 Interface		IIC		4-SPI
管脚 Pin		16pins 0.62 mm pitch		20pins 0.5 mm pitch
供电方式 Driving Power		Internal DC/DC		3.3-4.2V
	Supplied Externally	7.5V	Supplied Externally	7.5V

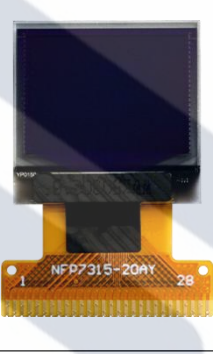
尺寸 Size		0.66 inch		0.66 inch
分辨率 Number of Pixels		64x48		64x48
驱动 Driver IC		ST7315P17		ST7315
显示区域 Active Area		10.06x13.42mm		10.06x13.42mm
面板尺寸 Panel Size		16.5 x16.2x 1.23mm		16.42 x16.2x 1.25mm
颜色 Color		Monochrome(White)		Monochrome(White)
接口 Interface		IIC/4-SPI		IIC
管脚 Pin		28pins 0.65 mm pitch		14pins 0.62 mm pitch
供电方式 Driving Power		Internal DC/DC		3.3-4.2V
	Supplied Externally	7.5V	Supplied Externally	7.5V

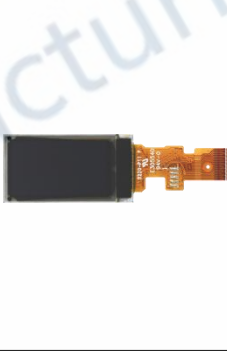

尺寸 Size		0.66 inch		0.69 inch
分辨率 Number of Pixels		64x48		96x16
驱动 Driver IC		ST7315		SSD1312
显示区域 Active Area		10.06x13.42mm		17.26x3.18mm
面板尺寸 Panel Size		16.42 x16.2x 1.25mm		24x6.9x1.25mm
颜色 Color		Monochrome(White)		Monochrome(White)
接口 Interface		IIC		IIC
管脚 Pin		28pins 0.65 mm pitch		14pins 0.62 mm pitch
供电方式 Driving Power		Internal DC/DC		3.3-4.2V
	Supplied Externally	7.5V	Supplied Externally	8V

尺寸 Size		0.69 inch		0.72 inch
分辨率 Number of Pixels		96x16		128x72
驱动 Driver IC		SSD1315		SSD1320
显示区域 Active Area		17.26x3.18mm		16.006x9.002mm
面板尺寸 Panel Size		26.3 x 8.0 x1.2mm		21.91x11.6x1.2mm
颜色 Color		Monochrome(White)		Monochrome(White)
接口 Interface		IIC		4-SPI
管脚 Pin		14pins 0.62 mm pitch		14pins 0.3 mm pitch
供电方式 Driving Power		Internal DC/DC		3.3-4.2V
	Supplied Externally	7.25V	Supplied Externally	13V

OLED单色裸屏 Monochrome OLED Screen

0.77~0.86 inch

尺寸 Size		0.77 inch		0.77 inch
分辨率 Number of Pixels		128x64		128x64
驱动 Driver IC		SSD1312		SSD1312
显示区域 Active Area		9.26x17.26mm		9.26x17.26mm
面板尺寸 Panel Size		12.13x23.6x1.22mm		12.13x23.6x1.22mm
颜色 Color		Monochrome(White)		Monochrome(White)
接口 Interface		4-SPI,IIC		IIC
管脚 Pin		13pins 0.7mm pitch		14pins 0.62 mm pitch
供电方式 Driving Power	Internal DC/DC	3.3-4.2V	Internal DC/DC	3.3-4.2V
	Supplied Externally	9.0V	Supplied Externally	9.0V

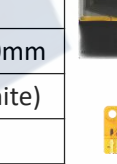

尺寸 Size		0.77 inch		0.78 inch
分辨率 Number of Pixels		128x64		128x80
驱动 Driver IC		SSD1312		SSD1317
显示区域 Active Area		9.26x17.26mm		19.372x7.858mm
面板尺寸 Panel Size		12.13x23.6x1.22mm		23.80x16.20x1.30mm
颜色 Color		Monochrome(White)		Monochrome(White)
接口 Interface		SPI		4-SPI ,IIC
管脚 Pin		15pins 0.65 mm pitch		13pins 0.7 mm pitch
供电方式 Driving Power	Internal DC/DC	3.3-4.2V	Internal DC/DC	3.3-4.2V
	Supplied Externally	9.0V	Supplied Externally	9.0V

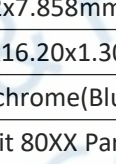
尺寸 Size		0.78 inch		0.82 inch
分辨率 Number of Pixels		128x80		96x39
驱动 Driver IC		SH1107		SSD1306
显示区域 Active Area		19.372x7.858mm		19.372x7.858mm
面板尺寸 Panel Size		23.80x16.20x1.30mm		23.80x16.20x1.30mm
颜色 Color		Monochrome(White)		Monochrome(Blue)
接口 Interface		4-SPI		IIC,8-bit 80XX Parallel
管脚 Pin		13pins 0.7 mm pitch		27pins 0.65 mm pitch
供电方式 Driving Power	Internal DC/DC	3.3-4.2V	Internal DC/DC	3.3-4.2V
	Supplied Externally	9.0V	Supplied Externally	7.25V



尺寸 Size		0.82 inch		0.86 inch
分辨率 Number of Pixels		96x39		96x32
驱动 Driver IC		SSD1306		SSD1316
显示区域 Active Area		19.372x7.858mm		21.1x6.06mm
面板尺寸 Panel Size		23.80x16.20x1.30mm		29.1x9.2x1.2mm
颜色 Color		(White/Blue)		Monochrome(White)
接口 Interface		4-SPI,IIC,8-bit 68XX/80XX		IIC
管脚 Pin		28pins 0.65 mm pitch		14pins 0.62 mm pitch
供电方式 Driving Power	Internal DC/DC	3.3-4.2V	Internal DC/DC	3.3-4.2V
	Supplied Externally	7.25V	Supplied Externally	8V

OLED单色裸屏 Monochrome OLED Screen

0.77~0.86 inch

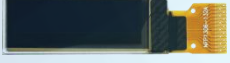
尺寸 Size		0.87 inch		0.87 inch
分辨率 Number of Pixels		128x32		128x32
驱动 Driver IC		SSD1312		SSD1316
显示区域 Active Area		22.38x5.58mm		21.356x5.324mm
面板尺寸 Panel Size		29x8.8x1.22mm		29x8.7x1.25mm
颜色 Color		Monochrome(White)		Monochrome(White)
接口 Interface		IIC		IIC
管脚 Pin		14pins 0.62 mm pitch		14pins 0.62 mm pitch
供电方式 Driving Power	Internal DC/DC	3.3-4.2V	Internal DC/DC	3.3-4.2V
	Supplied Externally	9V	Supplied Externally	9V

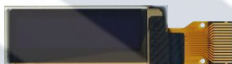

尺寸 Size		0.91 inch		0.91 inch
分辨率 Number of Pixels		128x32		128x32
驱动 Driver IC		SSD1306		SSD1306
显示区域 Active Area		22.384x5.584mm		22.384x5.584mm
面板尺寸 Panel Size		30.0x11.5x1.2mm		30.0x11.5x1.2mm
颜色 Color		(White/Blue/Yellow)		(White/Blue/Yellow)
接口 Interface		4-SPI		IIC
管脚 Pin		15pins 0.65 mm pitch		11pins 0.62 mm pitch
供电方式 Driving Power	Internal DC/DC	3.3-4.2V	Internal DC/DC	3.3-4.2V
	Supplied Externally	8V	Supplied Externally	8V



尺寸 Size		0.91 inch		0.91 inch
分辨率 Number of Pixels		128x32		128x32
驱动 Driver IC		SSD1306		SSD1306
显示区域 Active Area		22.384x5.584mm		22.384x5.584mm
面板尺寸 Panel Size		30.0x11.5x1.2mm		30.0x11.5x1.45mm
颜色 Color		Monochrome(White)		(White/Blue)
接口 Interface		4-SPI		4-SPI
管脚 Pin		15pins 0.5 mm pitch		15pins 0.5 mm pitch
供电方式 Driving Power	Internal DC/DC	3.3-4.2V	Internal DC/DC	3.3-4.2V
	Supplied Externally	7.5V	Supplied Externally	7.5V



尺寸 Size		0.91 inch		0.96 inch
分辨率 Number of Pixels		128x32		128x64
驱动 Driver IC		CH1115		SSD1315
显示区域 Active Area		22.384x5.584mm		21.74x10.86mm
面板尺寸 Panel Size		30.0x11.5x1.227mm		24.74x16.9x1.42mm
颜色 Color		Monochrome(White)		White/Blue/Yellow+Blue
接口 Interface		IIC		3-SPI/4-SPI/IIC
管脚 Pin		14pins 0.62 mm pitch		30pins 0.7mm pitch
供电方式 Driving Power	Internal DC/DC	3.3-4.2V	Internal DC/DC	3.3-4.2V
	Supplied Externally	8V	Supplied Externally	9V



OLED单色裸屏 Monochrome OLED Screen

0.96~0.96 inch

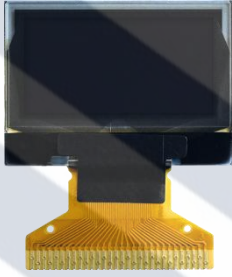
尺寸 Size		0.96 inch		0.96 inch
分辨率 Number of Pixels		128x64		128x64
驱动 Driver IC		SSD1315		SSD1315
显示区域 Active Area		21.74x11.175mm		21.74x10.86mm
面板尺寸 Panel Size		24.7x16.6x1.3mm		24.7x16.9x1.42mm
颜色 Color		Monochrome(White)		Monochrome(White)
接口 Interface		4-SPI		3-SPI/4-SPI/IIC
管脚 Pin		15pins 0.65mm pitch		15pins 0.5mm pitch
供电方式 Driving Power	Internal DC/DC	3.3-4.2V	Internal DC/DC	3.3-4.2V
	Supplied Externally	8.5V	Supplied Externally	9V

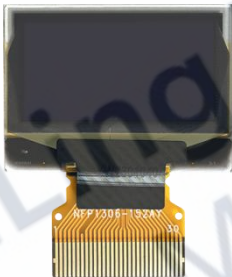

尺寸 Size		0.96 inch		0.96 inch
分辨率 Number of Pixels		128x64		128x64
驱动 Driver IC		SSD1315		SSD1315
显示区域 Active Area		21.74x10.86mm		21.74x11.175mm
面板尺寸 Panel Size		24.74x16.9x1.42mm		24.7x16.6x1.3mm
颜色 Color		(White/Blue)		White/Blue/Yellow+Blue
接口 Interface		3-SPI/4-SPI/IIC		4-SPI
管脚 Pin		30pins 0.5mm pitch		14pins 0.5mm pitch
供电方式 Driving Power	Internal DC/DC	3.3-4.2V	Internal DC/DC	3.3-4.2V
	Supplied Externally	9V	Supplied Externally	9V



尺寸 Size		0.96 inch		0.96 inch
分辨率 Number of Pixels		128x64		128x64
驱动 Driver IC		SSD1306/SSD1315		SSD1306
显示区域 Active Area		21.744x10.864mm		21.744x10.864mm
面板尺寸 Panel Size		26.70x19.26x1.4mm		26.70x19.26x1.4mm
颜色 Color		White/Blue/Yellow+Blue		White/Blue/Yellow+Blue
接口 Interface		SPI,IIC,8-bit 68XX/80XX		SPI,IIC,8-bit 68XX/80XX
管脚 Pin		30pins 0.7mm pitch		30pins 0.5mm pitch
供电方式 Driving Power	Internal DC/DC	3.3-4.2V	Internal DC/DC	3.3-4.2V
	Supplied Externally	9V	Supplied Externally	9V

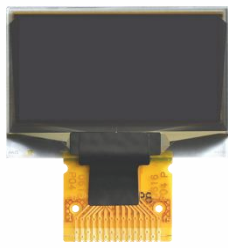

尺寸 Size		0.96 inch		0.96 inch
分辨率 Number of Pixels		128x64		128x64
驱动 Driver IC		SSD1306		SSD1306
显示区域 Active Area		21.744x11.204mm		21.744x10.864mm
面板尺寸 Panel Size		26.70x19.26x1.22mm		26.70x19.26x1.4mm
颜色 Color		White/Blue/Yellow+Blue		White/Blue/Yellow+Blue
接口 Interface		SPI,IIC,8-bit 68XX/80XX		SPI,IIC,8-bit 68XX/80XX
管脚 Pin		30pins 0.5mm pitch		30pins 0.5mm pitch
供电方式 Driving Power	Internal DC/DC	3.3-4.2V	Internal DC/DC	3.3-4.2V
	Supplied Externally	9V	Supplied Externally	9V

OLED单色裸屏 Monochrome OLED Screen

0.96~1.04 inch

尺寸 Size		0.96 inch		0.96 inch
分辨率 Number of Pixels		128x64		96x96
驱动 Driver IC		CH1116		SSD1317
显示区域 Active Area		21.74x11.18mm		17.26x17.26mm
面板尺寸 Panel Size		24.70x16.60x1.2mm		24.70x16.60x1.2mm
颜色 Color		White/Blue/Yellow+Blue		Monochrome(White)
接口 Interface		4-SPI		4-SPI
管脚 Pin		15pins 0.65mm pitch		12pins 0.7mm pitch
供电方式 Driving Power	Internal DC/DC	3.3-4.2V	Internal DC/DC	3.3-4.2V
	Supplied Externally	9V	Supplied Externally	12V



尺寸 Size		0.96 inch		0.96 inch
分辨率 Number of Pixels		64x128		64x128
驱动 Driver IC		CH1115		SSD1312
显示区域 Active Area		10.86x21.74mm		10.86x21.74mm
面板尺寸 Panel Size		13.62x27.9x1.227mm		14x28x1.22mm
颜色 Color		Monochrome(White)		Monochrome(White)
接口 Interface		4-SPI		4-SPI/IIC
管脚 Pin		15pins 0.65mm pitch		13pins 0.7mm pitch
供电方式 Driving Power	Internal DC/DC	3.3-4.2V	Internal DC/DC	3.3-4.2V
	Supplied Externally	9V	Supplied Externally	9V

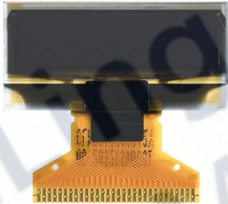

尺寸 Size		0.96 inch		0.96 inch
分辨率 Number of Pixels		64x128		64x128
驱动 Driver IC		SSD1312		SSD1312
显示区域 Active Area		10.86x21.74mm		10.86x21.74mm
面板尺寸 Panel Size		14x28x1.22mm		14x28x1.22mm
颜色 Color		Monochrome(White)		Monochrome(White)
接口 Interface		IIC		IIC
管脚 Pin		14pins 0.62mm pitch		14pins 0.62mm pitch
供电方式 Driving Power	Internal DC/DC	3.3-4.2V	Internal DC/DC	3.3-4.2V
	Supplied Externally		Supplied Externally	



尺寸 Size		1.04 inch		1.04 inch
分辨率 Number of Pixels		128x32		128x32
驱动 Driver IC		SSD1306		SSD1306
显示区域 Active Area		25.58x6.38mm		25.58x6.38mm
面板尺寸 Panel Size		29.80x14.50x1.3mm		29.80x14.50x1.3mm
颜色 Color		Monochrome(White)		Monochrome(White)
接口 Interface		SPI,IIC,8-bit 68XX/80XX		SPI,IIC,8-bit 68XX/80XX
管脚 Pin		30pins 0.7mm pitch		30pins 0.5mm pitch
供电方式 Driving Power	Internal DC/DC	3.3-4.2V	Internal DC/DC	3.3-4.2V
	Supplied Externally	7.25V	Supplied Externally	7.25V



OLED单色裸屏 Monochrome OLED Screen

1.19~1.12 inch

尺寸 Size		1.09 inch		1.09 inch
分辨率 Number of Pixels		64x128		64x128
驱动 Driver IC		SSD1312		SSD1312
显示区域 Active Area		10.86x25.58mm		10.86x25.58mm
面板尺寸 Panel Size		14x 31.96x1.2mm		14x 31.96x1.22mm
颜色 Color		Monochrome(White)		Monochrome(White)
接口 Interface		4-SPI		4-SPI,IIC
管脚 Pin		15pins 0.65mm pitch		16pins 0.7mm pitch
供电方式 Driving Power	Internal DC/DC	3.3-4.2V	Internal DC/DC	3.3-4.2V
	Supplied Externally	7.5V	Supplied Externally	7.5V



尺寸 Size		1.09 inch		1.12 inch
分辨率 Number of Pixels		64x128		96x96
驱动 Driver IC		SSD1312		SSD1327Z
显示区域 Active Area		10.86x25.58mm		20.14x20.14mm
面板尺寸 Panel Size		14x 31.96x1.22mm		24.50x 27.00x1.5mm
颜色 Color		Monochrome(White)		Monochrome(White)
接口 Interface		4-SPI		4-SPI
管脚 Pin		14pins 0.5mm pitch		14pins 0.5mm pitch
供电方式 Driving Power	Internal DC/DC	3.3-4.2V	Internal DC/DC	3.3-4.2V
	Supplied Externally	7.5V	Supplied Externally	8V



尺寸 Size		1.12 inch		1.12 inch
分辨率 Number of Pixels		128x128		128x128
驱动 Driver IC		SH1107		SH1107
显示区域 Active Area		20.14x20.14mm		20.14x20.14mm
面板尺寸 Panel Size		27x30.1x1.25mm		27x30.1x1.25mm
颜色 Color		Monochrome(White)		Monochrome(White)
接口 Interface		4-SPI,IIC,8-bit 68XX/80XX		4-SPI,IIC,8-bit 68XX/80XX
管脚 Pin		22pins 0.7mm pitch		22pins 0.7mm pitch
供电方式 Driving Power	Internal DC/DC	3.3-4.2V	Internal DC/DC	3.3-4.2V
	Supplied Externally	12V	Supplied Externally	13.5V



尺寸 Size		1.12 inch		1.12 inch
分辨率 Number of Pixels		128x128		128x128
驱动 Driver IC		SH1107		SH1107
显示区域 Active Area		20.14x20.14mm		20.076x20.076mm
面板尺寸 Panel Size		27x30.1x1.25mm		25.90x30.10x1.25mm
颜色 Color		Monochrome(White)		Monochrome(White)
接口 Interface		4-SPI,IIC,8-bit 68XX/80XX		4-SPI,IIC,8-bit 68XX/80XX
管脚 Pin		20pins 0.5mm pitch		12pins 0.5mm pitch
供电方式 Driving Power	Internal DC/DC	3.3-4.2V	Internal DC/DC	3.3-4.2V
	Supplied Externally	12V	Supplied Externally	13.5V



OLED单色裸屏 Monochrome OLED Screen

1.12~1.30 inch

尺寸 Size		1.21 inch		1.29 inch
分辨率 Number of Pixels		160x64		128x64
驱动 Driver IC		SSD1362Z		CH1115
显示区域 Active Area		28.78x10.86mm		14.7x29.42mm
面板尺寸 Panel Size		38x14.8x1.28mm		17.1x35.8x1.22mm
颜色 Color		Monochrome(White)		Monochrome(White)
接口 Interface		4-SPI		4-SPI,IIC
管脚 Pin		12pins 0.5mm pitch		16pins 0.7mm pitch
供电方式 Driving Power	Internal DC/DC	3.3-4.2V	Internal DC/DC	3.3-4.2V
	Supplied Externally	13V	Supplied Externally	8V



尺寸 Size		1.29 inch		1.29 inch
分辨率 Number of Pixels		128x64		128x64
驱动 Driver IC		CH1115		SSD1315
显示区域 Active Area		14.7x29.42mm		29.42x14.7mm
面板尺寸 Panel Size		17.1x35.8x1.22mm		32.42x21.36x1.427mm
颜色 Color		Monochrome(White)		(White/Blue)
接口 Interface		4-SPI,IIC		4-SPI,IIC,8-bit 68XX/80XX
管脚 Pin		16pins 0.5mm pitch		30pins 0.7mm pitch
供电方式 Driving Power	Internal DC/DC	3.3-4.2V	Internal DC/DC	3.3-4.2V
	Supplied Externally	8V	Supplied Externally	9V



尺寸 Size		1.29 inch		1.29 inch
分辨率 Number of Pixels		128x64		128x64
驱动 Driver IC		SSD1315		SSD1315
显示区域 Active Area		29.42x14.7mm		29.42x14.7mm
面板尺寸 Panel Size		32.42x21.36x1.427mm		32.42x21.36x1.427mm
颜色 Color		(White/Blue)		(White/Blue)
接口 Interface		SPI,IIC,8-bit 68XX/80XX		4-SPI
管脚 Pin		30pins 0.5mm pitch		16pins 0.5mm pitch
供电方式 Driving Power	Internal DC/DC	3.3-4.2V	Internal DC/DC	3.3-4.2V
	Supplied Externally	12V	Supplied Externally	12V



尺寸 Size		1.30 inch		1.30 inch
分辨率 Number of Pixels		64x128		64x128
驱动 Driver IC		SH1107		SH1107
显示区域 Active Area		14.7x29.42mm		14.7x29.42mm
面板尺寸 Panel Size		17.1x35.8x1.43mm		17.1x35.8x1.43mm
颜色 Color		Monochrome(White)		Monochrome(White)
接口 Interface		4-SPI,IIC		4-SPI,IIC
管脚 Pin		16pins 0.7mm pitch		13pins 0.7mm pitch
供电方式 Driving Power	Internal DC/DC	3.3-4.2V	Internal DC/DC	3.3-4.2V
	Supplied Externally	9V	Supplied Externally	9V

OLED单色裸屏 Monochrome OLED Screen

1.30~1.30 inch

尺寸 Size		1.30 inch		1.30 inch
分辨率 Number of Pixels		64x128		64x128
驱动 Driver IC		SSD1312		SSD1312
显示区域 Active Area		14.7x29.42mm		14.7x29.42mm
面板尺寸 Panel Size		17.1x35.8x1.43mm		17.1x35.8x1.43mm
颜色 Color		Monochrome(White)		Monochrome(White)
接口 Interface		4-SPI,IIC		4-SPI,IIC
管脚 Pin		13pins 0.7mm pitch		14pins 0.62mm pitch
供电方式 Driving Power	Internal DC/DC	3.3-4.2V	Internal DC/DC	3.3-4.2V
	Supplied Externally	9V	Supplied Externally	9V

尺寸 Size		1.30 inch		1.30 inch
分辨率 Number of Pixels		64x128		128x64
驱动 Driver IC		SSD1312		SSD1306
显示区域 Active Area		14.7x29.42mm		29.42x14.7mm
面板尺寸 Panel Size		17.1x35.8x1.43mm		34.5x23.0x1.45mm
颜色 Color		Monochrome(White)		Monochrome(White)
接口 Interface		4-SPI,IIC		SPI,IIC,8-bit 68XX/80XX
管脚 Pin		16pins 0.5mm pitch		30pins 0.7mm pitch
供电方式 Driving Power	Internal DC/DC	3.3-4.2V	Internal DC/DC	3.3-4.2V
	Supplied Externally	9V	Supplied Externally	12V



尺寸 Size		1.30 inch		1.30 inch
分辨率 Number of Pixels		128x64		128x64
驱动 Driver IC		SSD1306		SSD1306
显示区域 Active Area		29.42x14.7mm		29.42x14.7mm
面板尺寸 Panel Size		34.5x23.0x1.45mm		34.5x23.0x1.45mm
颜色 Color		Monochrome(White)		Monochrome(White)
接口 Interface		SPI,IIC,8-bit 68XX/80XX		4-SPI
管脚 Pin		30pins 0.5mm pitch		16pins 0.5mm pitch
供电方式 Driving Power	Internal DC/DC	3.3-4.2V	Internal DC/DC	3.3-4.2V
	Supplied Externally	12V	Supplied Externally	12V



尺寸 Size		1.30 inch		1.30 inch
分辨率 Number of Pixels		128x64		128x64
驱动 Driver IC		SH1106		SH1106,SSD1306
显示区域 Active Area		29.42x14.7mm		29.42x14.7mm
面板尺寸 Panel Size		34.5x23.0x1.4mm		34.5x23.0x1.4mm
颜色 Color		(White/Blue)		(White/Blue)
接口 Interface		SPI,IIC,8-bit 68XX/80XX		SPI,IIC,8-bit 68XX/80XX
管脚 Pin		30pins 0.7mm pitch		30pins 0.7mm pitch
供电方式 Driving Power	Internal DC/DC	3.3-4.2V	Internal DC/DC	3.3-4.2V
	Supplied Externally	12V	Supplied Externally	12V



OLED单色裸屏 Monochrome OLED Screen

1.30~1.50 inch

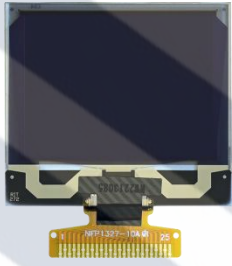
尺寸 Size		1.30 inch		1.30 inch
分辨率 Number of Pixels		128x64		128x64
驱动 Driver IC		SH1106		SH1106
显示区域 Active Area		29.42x14.7mm		29.42x14.7mm
面板尺寸 Panel Size		34.5x23.0x1.4mm		34.5x23.0x1.4mm
颜色 Color		(White/Blue)		(White/Blue)
接口 Interface		SPI,IIC,8-bit 68XX/80XX		4-SPI
管脚 Pin		30pins 0.5mm pitch		16pins 0.5mm pitch
供电方式 Driving Power	Internal DC/DC	3.3-4.2V	Internal DC/DC	3.3-4.2V
	Supplied Externally	12V	Supplied Externally	12V



尺寸 Size		1.32 inch		1.32 inch
分辨率 Number of Pixels		128x96		128x96
驱动 Driver IC		SSD1327		SSD1327
显示区域 Active Area		26.86x20.14mm		26.86x20.14mm
面板尺寸 Panel Size		32.6x28.3x1.6mm		32.6x28.3x1.6mm
颜色 Color		Monochrome(White)		Monochrome(White)
接口 Interface		4-SPI,IIC,8-bit 68XX/80XX		4-SPI
管脚 Pin		25pins 0.65mm pitch		16pins 0.65mm pitch
供电方式 Driving Power	Internal DC/DC	3.3-4.2V	Internal DC/DC	3.3-4.2V
	Supplied Externally	15V	Supplied Externally	15V



尺寸 Size		1.32 inch		1.32 inch
分辨率 Number of Pixels		128x96		128x96
驱动 Driver IC		SSD1327		SSD1327
显示区域 Active Area		26.86x20.14mm		26.86x20.14mm
面板尺寸 Panel Size		32.6x28.3x1.61mm		32.5x29.2x1.63mm
颜色 Color		Monochrome(White)		Monochrome(White)
接口 Interface		SPI,IIC,8-bit 68XX/80XX		4-SPI
管脚 Pin		25pins 0.65mm pitch		16pins 0.65mm pitch
供电方式 Driving Power	Internal DC/DC	3.3-4.2V	Internal DC/DC	3.3-4.2V
	Supplied Externally	15V	Supplied Externally	15V

尺寸 Size		1.5 inch		1.5 inch
分辨率 Number of Pixels		128x128		128x128
驱动 Driver IC		SH1107		SH1107
显示区域 Active Area		26.855x26.855mm		26.855x26.855mm
面板尺寸 Panel Size		33.9x37.3x1.44mm		33.9x37.3x1.44mm
颜色 Color		(White/Yellow)		(White/Yellow)
接口 Interface		SPI,IIC,8-bit 68XX/80XX		4-SPI
管脚 Pin		25pins 0.65mm pitch		12pins 0.5mm pitch
供电方式 Driving Power	Internal DC/DC	3.3-4.2V	Internal DC/DC	3.3-4.2V
	Supplied Externally	12V	Supplied Externally	12V



OLED单色裸屏 Monochrome OLED Screen

1.50~1.71 inch

尺寸 Size		1.5 inch		1.5 inch
分辨率 Number of Pixels		128x128		128x128
驱动 Driver IC		SSD1327		SSD1327
显示区域 Active Area		26.86x26.86mm		26.86x26.86mm
面板尺寸 Panel Size		33.8x36.5x1.41mm		33.8x36.5x1.427mm
颜色 Color		(White/Yellow)		(White/Yellow)
接口 Interface		SPI,IIC,8-bit 68XX/80XX		SPI,IIC,8-bit 68XX/80XX
管脚 Pin		25pins 0.65mm pitch		24pins 0.5mm pitch
供电方式 Driving Power	Internal DC/DC	3.3-4.2V	Internal DC/DC	3.3-4.2V
	Supplied Externally	15V	Supplied Externally	15V



尺寸 Size		1.5 inch		1.51 inch
分辨率 Number of Pixels		128x128		128x56
驱动 Driver IC		SH1107		SSD1309
显示区域 Active Area		26.855x26.855mm		35.05x15.32mm
面板尺寸 Panel Size		33.9x37.3x1.44mm		42.04x27.22x1.25mm
颜色 Color		Monochrome(White)		Monochrome(Blue)
接口 Interface		4-SPI,IIC,8-bit 68XX/80XX		4-SPI,IIC,8-bit 68XX/80XX
管脚 Pin		20pins 0.5mm pitch		24pins 0.5mm pitch
供电方式 Driving Power	Internal DC/DC	3.3-4.2V	Internal DC/DC	3.3-4.2V
	Supplied Externally	12V	Supplied Externally	12.5V



尺寸 Size		1.54 inch		1.54 inch
分辨率 Number of Pixels		128x64		128x64
驱动 Driver IC		SSD1305		SSD1309/CH1116
显示区域 Active Area		35.056x17.52mm		35.052x17.516mm
面板尺寸 Panel Size		45.24x29.14x2.0mm		42.04x27.22x1.45mm
颜色 Color		Monochrome(Yellow)		White/Blue/Yellow
接口 Interface		4-SPI,IIC,8-bit 68XX/80XX		4-SPI,IIC,8-bit 68XX/80XX
管脚 Pin		24pins 0.5mm pitch		24pins 0.5mm pitch
供电方式 Driving Power	Internal DC/DC	3.3-4.2V	Internal DC/DC	3.3-4.2V
	Supplied Externally	12.5V	Supplied Externally	12.5V



尺寸 Size		1.71 inch		1.71 inch
分辨率 Number of Pixels		128x32		128x32
驱动 Driver IC		SSD1312		SSD1312
显示区域 Active Area		42.218x10.538mm		42.218x10.538mm
面板尺寸 Panel Size		50.5x15.75x2.0mm		50.5x15.75x2.0mm
颜色 Color		Monochrome(White)		Monochrome(White)
接口 Interface		4-SPI,IIC		SPI,IIC
管脚 Pin		16pins 0.7mm pitch		18pins 0.5mm pitch
供电方式 Driving Power	Internal DC/DC	3.3-4.2V	Internal DC/DC	3.3-4.2V
	Supplied Externally	10V	Supplied Externally	12V



OLED单色裸屏 Monochrome OLED Screen

1.92~2.23 inch

尺寸 Size		1.92 inch		1.92 inch
分辨率 Number of Pixels		128x160		128x160
驱动 Driver IC		SH1108		SH1108
显示区域 Active Area		39.34x28.908mm		39.34x28.908mm
面板尺寸 Panel Size		46.55x32.9x1.427mm		46.55x32.9x1.427mm
颜色 Color		Monochrome(White)		Monochrome(White)
接口 Interface		SPI,IIC,8-bit 68XX/80XX		SPI,IIC,8-bit 68XX/80XX
管脚 Pin		30pins 0.5mm pitch		31pins 0.3mm pitch
供电方式 Driving Power	Internal DC/DC	3.3-4.2V	Internal DC/DC	3.3-4.2V
	Supplied Externally	13.5V	Supplied Externally	13.5V

尺寸 Size		2.08 inch		2.08 inch
分辨率 Number of Pixels		128x32		256x64
驱动 Driver IC		SSD1307		SH1122
显示区域 Active Area		51.18x12.78mm		51.18x12.78mm
面板尺寸 Panel Size		62.5x20.6x1.63mm		60.5x19.0x1.6mm
颜色 Color		Monochrome(White)		White/Blue
接口 Interface		SPI,IIC,8-bit 68XX/80XX		SPI,IIC,8-bit 68XX/80XX
管脚 Pin		24pins 0.7mm pitch		24pins 0.7mm pitch
供电方式 Driving Power	Internal DC/DC	3.3-4.2V	Internal DC/DC	3.3-4.2V
	Supplied Externally	9V	Supplied Externally	14.5V



尺寸 Size		2.08 inch		2.23 inch
分辨率 Number of Pixels		256x64		128x32
驱动 Driver IC		SH1122		SSD1305
显示区域 Active Area		51.18x12.78mm		55.02x13.10mm
面板尺寸 Panel Size		62.50x20.6x1.6mm		62.00x24.00x2.0mm
颜色 Color		Monochrome(White)		White/Blue
接口 Interface		4-SPI		4-SPI,IIC,8-bit 68XX/80XX
管脚 Pin		14pins 0.5mm pitch		24pins 0.5mm pitch
供电方式 Driving Power	Internal DC/DC	3.3-4.2V	Internal DC/DC	3.3-4.2V
	Supplied Externally	12V	Supplied Externally	12.5V



尺寸 Size		2.23 inch		2.23 inch
分辨率 Number of Pixels		128x32		128x32
驱动 Driver IC		SSD1305		SSD1305
显示区域 Active Area		55.02x13.10mm		55.02x13.10mm
面板尺寸 Panel Size		62.00x24.00x2.0mm		62.00x24.00x1.8mm
颜色 Color		White/Blue/Yellow/Green		Monochrome (Orange)
接口 Interface		4-SPI,IIC,8-bit 68XX/80XX		4-SPI,IIC,8-bit 68XX/80XX
管脚 Pin		24pins 0.5mm pitch		24pins 0.5mm pitch
供电方式 Driving Power	Internal DC/DC	3.3-4.2V	Internal DC/DC	3.3-4.2V
	Supplied Externally	12.5V	Supplied Externally	12.5V



OLED单色裸屏 Monochrome OLED Screen

2.42~2.70 inch

尺寸 Size		2.42 inch		2.42 inch
分辨率 Number of Pixels		128x64		128x64
驱动 Driver IC		SSD1305		SSD1305
显示区域 Active Area		55.01x27.49mm		55.01x27.49mm
面板尺寸 Panel Size		60.50x37.00x2.0mm		60.50x37.00x2.0mm
颜色 Color		Monochrome(White)		White/Blue/Yellow/Green
接口 Interface		4-SPI,IIC,8-bit 68XX/80XX		4-SPI,IIC,8-bit 68XX/80XX
管脚 Pin	31pins 1.0mm pitch	31pins 1.0mm pitch		
供电方式 Driving Power	Internal DC/DC	3.3-4.2V	Internal DC/DC	3.3-4.2V
	Supplied Externally	13V	Supplied Externally	13V

尺寸 Size		2.42 inch		2.45 inch
分辨率 Number of Pixels		128x64		304x96
驱动 Driver IC		SSD1309		SH1126G
显示区域 Active Area		55.01x27.49mm		59.26x19.18mm
面板尺寸 Panel Size		60.50x37.00x2.0mm		72x28.2x1.4mm
颜色 Color		White/Blue/Yellow/Green		Monochrome(Blue)
接口 Interface		4-SPI,IIC,8-bit 68XX/80XX		SPI,IIC,8-bit 68XX/80XX
管脚 Pin	24pins 0.5mm pitch	31pins 0.3mm pitch		
供电方式 Driving Power	Internal DC/DC	3.3-4.2V	Internal DC/DC	3.3-4.2V
	Supplied Externally	13V	Supplied Externally	9.0V

尺寸 Size		2.55 inch		2.60 inch
分辨率 Number of Pixels		206x36		128x64
驱动 Driver IC		SSD1362		SPD0301
显示区域 Active Area		63.84x11.14mm		58.85x29.41mm
面板尺寸 Panel Size		71.02x16.14x2.00mm		64.61x37x2.02mm
颜色 Color		Monochrome(White)		White/Yellow
接口 Interface		4-SPI,IIC		SPI,IIC,8-bit 68XX/80XX
管脚 Pin	20pins 0.5mm pitch	22pins 0.5mm pitch		
供电方式 Driving Power	Internal DC/DC	3.3-4.2V	Internal DC/DC	3.3-4.2V
	Supplied Externally	12V	Supplied Externally	8V



尺寸 Size		2.70 inch		2.70 inch
分辨率 Number of Pixels		128x64		128x64
驱动 Driver IC		SSD1322		SSD1325
显示区域 Active Area		61.41x30.69mm		61.41x30.69mm
面板尺寸 Panel Size		73.00x41.86x2.0mm		73.00x41.86x2.2mm
颜色 Color		Yellow/Green		White/Yellow/Green
接口 Interface		SPI,8-bit 68XX/80XX		4-SPI,8-bit 68XX/80XX
管脚 Pin	30pins 0.5mm pitch	30pins 0.5mm pitch		
供电方式 Driving Power	Internal DC/DC	3.3-4.2V	Internal DC/DC	3.3-4.2V
	Supplied Externally	15V	Supplied Externally	15V

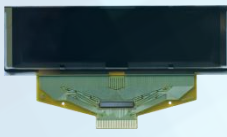

OLED单色裸屏 Monochrome OLED Screen

2.70~5.50 inch

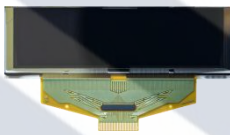
尺寸 Size		2.70 inch		2.70 inch
分辨率 Number of Pixels		128x64		256x128
驱动 Driver IC		SSD1325		SSD1363
显示区域 Active Area		61.41×30.69mm		61.41×30.7mm
面板尺寸 Panel Size		73.00×41.86×2.0mm		73.00×41.86×2.0mm
颜色 Color		Monochrome(White)		White/Yellow/Green
接口 Interface		4-SPI,8-bit 68XX/80XX		4-SPI,IIC,8-bit 68XX/80XX
管脚 Pin		30pins 0.5mm pitch		30pins 0.5mm pitch
供电方式 Driving Power	Internal DC/DC	3.3-4.2V	Internal DC/DC	3.3-4.2V
	Supplied Externally	15V	Supplied Externally	15V

尺寸 Size		2.70 inch		2.80 inch
分辨率 Number of Pixels		256x64		256x64
驱动 Driver IC		SSD1322		SSD1322
显示区域 Active Area		66.53×16.61mm		69.104×17.264mm
面板尺寸 Panel Size		72.00×25.50×2.0mm		84.00×25.80×2.0mm
颜色 Color		White/Yellow/Green		White/Blue/Yellow
接口 Interface		4-SPI,IIC,8-bit 68XX/80XX		4-SPI,8-bit 68XX/80XX
管脚 Pin		13pins 0.5mm pitch		30pins 0.5mm pitch
供电方式 Driving Power	Internal DC/DC	3.3-4.2V	Internal DC/DC	3.3-4.2V
	Supplied Externally	14V	Supplied Externally	12V

尺寸 Size		3.12 inch		3.12 inch
分辨率 Number of Pixels		256x64		256x64
驱动 Driver IC		SSD1322		SSD1362
显示区域 Active Area		76.78×19.18mm		76.78×19.18mm
面板尺寸 Panel Size		88.00×27.80×2.0mm		88.00×27.80×2.0mm
颜色 Color		White/Blue/Yellow/Green		Monochrome(White)
接口 Interface		SPI,8-bit 68XX/80XX		4-SPI,IIC,8-bit 68XX/80XX
管脚 Pin		30pins 0.5mm pitch		24pins 0.5mm pitch
供电方式 Driving Power	Internal DC/DC	3.3-4.2V	Internal DC/DC	3.3-4.2V
	Supplied Externally	12V	Supplied Externally	12V



尺寸 Size		3.83 inch		5.50 inch
分辨率 Number of Pixels		132x320		256x64
驱动 Driver IC		SSD1320*2		SSD1322
显示区域 Active Area		89.9×37.072mm		135.65×33.89mm
面板尺寸 Panel Size		105.52×41.762×2.027		146×45×2.0mm
颜色 Color		Monochrome(White)		White/Blue/Yellow/Green
接口 Interface		SPI		SPI,8-bit 68XX/80XX
管脚 Pin		16pins 0.5mm pitch		30pins 0.5mm pitch
供电方式 Driving Power	Internal DC/DC	3.3-4.2V	Internal DC/DC	3.3-4.2V
	Supplied Externally	8V	Supplied Externally	15V

OLED彩色裸屏 Full Color OLED Screen

0.60 ~1.45 inch

尺寸 Size		0.6 inch		0.76 inch
分辨率 Number of Pixels		64x64		28x95
驱动 Driver IC		SSD1357Z		PT6891
显示区域 Active Area		10.73x10.73mm		18.505x5.43mm
面板尺寸 Panel Size		15.00x17.50x1.20mm		8.7x25.5x1.427mm
颜色 Color		65,536 Colors (Max)		RGB
接口 Interface		SPI		4-SPI
管脚 Pin		20pins 0.5mm pitch		12pins 0.5mm pitch
供电方式 Driving Power	Internal DC/DC	1.65-3.5V	Internal DC/DC	2.4-3.6V
	Supplied Externally	12V	Supplied Externally	15V



尺寸 Size		0.95 inch		0.95 inch
分辨率 Number of Pixels		96x64		96x64
驱动 Driver IC		SSD1331Z		SSD1331Z
显示区域 Active Area		20.135x13.42mm		20.14x13.42mm
面板尺寸 Panel Size		24.8x17.32x1.28mm		25.7x22.2x1.2mm
颜色 Color		65k Full Color		65,536 Colors (Max)
接口 Interface		SPI,8-bit 68XX/80XX		4-SPI,8-bit 68XX/80XX
管脚 Pin		23pins 0.7mm pitch		23pins 0.7mm pitch
供电方式 Driving Power	Internal DC/DC	2.4-3.5V	Internal DC/DC	2.4-3.5V
	Supplied Externally	10V	Supplied Externally	14V

尺寸 Size		0.96 inch		1.27 inch
分辨率 Number of Pixels		64x128		128x96
驱动 Driver IC		SSD1357Z		SSD1351
显示区域 Active Area		10.924x21.74mm		19.82x25.708mm
面板尺寸 Panel Size		28.4x14.86x1.02mm		33.7x26.9x1.6mm
颜色 Color		Full Color		262,144 Colors (Max)
接口 Interface		SPI,8-bit 68XX/80XX		SPI,8-bit 68XX/80XX
管脚 Pin		31pins 0.3mm pitch		30pins 0.5mm pitch
供电方式 Driving Power	Internal DC/DC	1.65-3.5V	Internal DC/DC	2.4-2.6V
	Supplied Externally	15V	Supplied Externally	12V

尺寸 Size		1.45 inch		1.45 inch
分辨率 Number of Pixels		160x128		160x128
驱动 Driver IC		SEP525		SSD1333
显示区域 Active Area		28.78x23.024mm		28.78x23.024mm
面板尺寸 Panel Size		35.8x30.08x1.4mm		35.8x30.08x1.6mm
颜色 Color		262,144 Colors (Max)		262,144 Colors (Max)
接口 Interface		SPI,8-bit 68XX/80XX		4-SPI,IIC,8-bit 68XX/80XX
管脚 Pin		30pins 0.5mm pitch		30pins 0.5mm pitch
供电方式 Driving Power	Internal DC/DC	2.6-3.3V	Internal DC/DC	1.65-3.5V
	Supplied Externally	13V	Supplied Externally	13V

OLED彩色裸屏 Full Color OLED Screen

1.50~1.90 inch



尺寸 Size		1.50 inch		1.69 inch
分辨率 Number of Pixels		128x128		160x128
驱动 Driver IC		SSD1333		SEP525
显示区域 Active Area		26.855x26.864mm		33.575x26.864mm
面板尺寸 Panel Size		33.8x34x1.6mm		39.9x34x1.6mm
颜色 Color		262,144 Colors (Max)		262,144 Colors (Max)
接口 Interface		4-SPI,8-bit 68XX/80XX		4-SPI,8-bit 68/80XX,6-rgb
管脚 Pin		30pins 0.5mm pitch		35pins 0.5mm pitch
供电方式 Driving Power	Internal DC/DC	2.4-2.6V	Internal DC/DC	2.6-3.3V
	Supplied Externally	13V	Supplied Externally	14V



尺寸 Size		1.69 inch		
分辨率 Number of Pixels		160x128		
驱动 Driver IC		SSD1333		
显示区域 Active Area		33.575x26.864mm		
面板尺寸 Panel Size		39.9x34x1.6mm		
颜色 Color		262,144 Colors (Max)		
接口 Interface		4-SPI,IIC,8-bit 68XX/80XX		
管脚 Pin		30pins 0.5mm pitch		
供电方式 Driving Power	Internal DC/DC	1.65-3.5V		
	Supplied Externally	14V		

TFT彩色裸屏 Full Color TFT Screen

0.42~0.96 inch

尺寸 Size		0.42 inch IPS		0.60 inch IPS
分辨率 Number of Pixels		96x54		128x150
驱动 Driver IC		ST7735P3		ST7735P3
显示区域 Active Area		9.22x5.18mm		9.22x5.18mm
面板尺寸 Panel Size		12.32x12.09x1.50mm		12.16x15.43x1.41mm
颜色 Color		262K Colors		RGB
接口 Interface		4-SPI		4-SPI
管脚 Pin		16pins 0.65mm pitch		12pins 0.7mm pitch
系统供电 System Voltage		2.7-3.3V		2.4-3.3V



尺寸 Size		0.71 inch IPS		0.85 inch IPS
分辨率 Number of Pixels		160x160		128x128
驱动 Driver IC		GC9D01		GC9107
显示区域 Active Area		17.76x18mm		15.21x15.21mm
面板尺寸 Panel Size		20.12x22.30x1.41mm		17.58x20.82x1.46mm
颜色 Color		RGB		RGB Vvertical stripe
接口 Interface		4-SPI		4-SPI
管脚 Pin		12pins 0.7mm pitch		12pins 0.7mm pitch
系统供电 System Voltage		2.4-3.3V		2.4-3.3V

尺寸 Size		0.85 inch IPS		0.85 inch IPS
分辨率 Number of Pixels		128x128		128x128
驱动 Driver IC		GC9107		GC9107
显示区域 Active Area		15.21x15.21mm		15.21x15.21mm
面板尺寸 Panel Size		17.58x20.82x1.46mm		17.58x20.82x1.46mm
颜色 Color		RGB Vvertical stripe		RGB Vvertical stripe
接口 Interface		4-SPI		4-SPI
管脚 Pin		8pins 0.5mm pitch		12pins 0.5mm pitch
系统供电 System Voltage		2.4-3.3V		2.4-3.3V

尺寸 Size		0.96 inch		0.96 inch IPS
分辨率 Number of Pixels		128x64		80x160
驱动 Driver IC		GC9107		ST7735S
显示区域 Active Area		21.744x10.864mm		10.80x21.70mm
面板尺寸 Panel Size		26.70x19.26x1.60mm		13.5x27.95x1.5mm
颜色 Color		262K		RGB Vvertical stripe
接口 Interface		4-SPI		4-SPI
管脚 Pin		30pins 0.7mm pitch		13pins 0.7mm pitch
系统供电 System Voltage		2.4-3.2V		2.5-3.3V

TFT彩色裸屏 Full Color TFT Screen

0.96~0.99 inch

尺寸 Size		0.96 inch IPS		0.96 inch IPS
分辨率 Number of Pixels		80x160		80x160
驱动 Driver IC		ST7735S		ST7735S
显示区域 Active Area		10.80x21.70mm		10.80x21.70mm
面板尺寸 Panel Size		13.5x27.95x1.5mm		13.5x27.95x1.5mm
颜色 Color		RGB Vvertical stripe		RGB Vvertical stripe
接口 Interface		4-SPI		4-SPI
管脚 Pin		8pins 0.5mm pitch		8pins 0.5mm pitch
系统供电 System Voltage		2.5-3.3V		2.5-3.3V



尺寸 Size		0.96 inch IPS		0.96 inch IPS
分辨率 Number of Pixels		80x160		80x160
驱动 Driver IC		ST7735S		ST7735S
显示区域 Active Area		10.80x21.70mm		10.80x21.70mm
面板尺寸 Panel Size		13.5x27.95x1.5mm		13.5x27.95x1.5mm
颜色 Color		RGB Vvertical stripe		RGB Vvertical stripe
接口 Interface		4-SPI		4-SPI
管脚 Pin		13pins 0.5mm pitch		8pins 0.5mm pitch
系统供电 System Voltage		2.5-3.3V		2.5-3.3V

尺寸 Size		0.99 inch IPS		0.99 inch IPS
分辨率 Number of Pixels		40x160		40x160
驱动 Driver IC		GC9D01		GC9D01
显示区域 Active Area		6.059x24.385mm		6.059x24.385mm
面板尺寸 Panel Size		8.6x29.8x1.5mm		8.6x29.8x1.5mm
颜色 Color		RGB Vvertical stripe		RGB Vvertical stripe
接口 Interface		4-SPI		4-SPI
管脚 Pin		10pins 0.7mm pitch		10pins 0.5mm pitch
系统供电 System Voltage		2.4-3.3V		2.4-3.3V

尺寸 Size		0.99 inch IPS		0.99 inch IPS
分辨率 Number of Pixels		40x160		128x115
驱动 Driver IC		GC9D01		GC9107
显示区域 Active Area		6.059x24.385mm		24.36x21.89mm
面板尺寸 Panel Size		8.6x29.8x1.5mm		26.71x26.22x1.86mm
颜色 Color		RGB Vvertical stripe		RGB Vvertical stripe
接口 Interface		4-SPI		4-SPI
管脚 Pin		8pins 0.5mm pitch		12pins 0.7mm pitch
系统供电 System Voltage		2.4-3.3V		2.5-3.3V



TFT彩色裸屏 Full Color TFT Screen

0.99~1.14 inch

尺寸 Size		0.99 inch IPS		0.99 inch IPS
分辨率 Number of Pixels		128x115		128x115
驱动 Driver IC		GC9107		GC9107
显示区域 Active Area		24.36x21.89mm		24.36x21.89mm
面板尺寸 Panel Size		26.71x26.22x1.86mm		26.71x26.22x1.86mm
颜色 Color		RGB Vvertical stripe		RGB Vvertical stripe
接口 Interface		4-SPI		4-SPI
管脚 Pin		7pins 0.5mm pitch		11pins 0.5mm pitch
系统供电 System Voltage		2.5-3.3V		2.5-3.3V



尺寸 Size		1.05 inch IPS		1.06 inch IPS
分辨率 Number of Pixels		120x240		96x160
驱动 Driver IC		GC9A01		GC9107
显示区域 Active Area		11.88x23.76mm		13.82x23.0mm
面板尺寸 Panel Size		14.25x28.60x1.60mm		16.12x29.76x1.52mm
颜色 Color		262K		RGB Vvertical stripe
接口 Interface		4-SPI		4-SPI
管脚 Pin		13pins 0.7mm pitch		13pins 0.7mm pitch
系统供电 System Voltage		2.5-3.3V		2.5-3.3V

尺寸 Size		1.08 inch IPS		1.08 inch IPS
分辨率 Number of Pixels		128x220		128x220
驱动 Driver IC		GC9A01		GC9203
显示区域 Active Area		13.82x23.76mm		13.82x23.76mm
面板尺寸 Panel Size		16.12x29.76x1.52mm		16.12x29.76x1.52mm
颜色 Color		RGB Vvertical stripe		RGB Vvertical stripe
接口 Interface		4-SPI		4-SPI
管脚 Pin		13pins 0.7mm pitch		13pins 0.7mm pitch
系统供电 System Voltage		2.5-3.3V		2.5-3.3V



尺寸 Size		1.12 inch IPS		1.14 inch IPS
分辨率 Number of Pixels		50x160		135x240
驱动 Driver IC		GC9D01		ST7789V3
显示区域 Active Area		8.49x27.17mm		14.86x24.91mm
面板尺寸 Panel Size		10.8x32.18x2.11mm		17.6x31x1.6mm
颜色 Color		RGB Vvertical stripe		262K
接口 Interface		4-SPI		4-SPI
管脚 Pin		13pins 0.7mm pitch		13pins 0.7mm pitch
系统供电 System Voltage		2.5-3.3V		2.5-3.3V

TFT彩色裸屏 Full Color TFT Screen

1.14~1.30 inch

尺寸 Size		1.14 inch IPS		1.14 inch DCT IPS
分辨率 Number of Pixels		135x240		135x240
驱动 Driver IC		ST7789V3		ST7789V3
显示区域 Active Area		14.86x24.91mm		14.86x24.91mm
面板尺寸 Panel Size		17.6x31x1.6mm		24.62x39.5x2.725mm
颜色 Color		262K		262K
接口 Interface		4-SPI		4-SPI
管脚 Pin		8pins 0.5mm pitch		18pins 0.5mm pitch
系统供电 System Voltage		2.5-3.3V		2.5-3.3V

尺寸 Size		1.28 inch DCT IPS		1.28 inch IPS
分辨率 Number of Pixels		240x240		240x240
驱动 Driver IC		GC9A01		GC9A01
显示区域 Active Area		32.40x32.40mm		32.40x32.40mm
面板尺寸 Panel Size		36.6x37.74x3.78mm		36.6x37.74x1.5mm
颜色 Color		262K		262K
接口 Interface		8 Bit 8080 MCU		4-SPI
管脚 Pin		25pins 0.5mm pitch		12pins 0.7mm pitch
系统供电 System Voltage		2.5-3.3V		2.5-3.3V

尺寸 Size		1.28 inch IPS		1.3 inch IPS
分辨率 Number of Pixels		240x240		240x240
驱动 Driver IC		GC9A01		ST7789V2
显示区域 Active Area		32.40x32.40mm		23.40x23.40mm
面板尺寸 Panel Size		36.6x37.74x1.55mm		26.16x29.22x1.5mm
颜色 Color		262K		65K
接口 Interface		4-SPI		4-SPI
管脚 Pin		15pins 0.3mm pitch		12pins 0.7mm pitch
系统供电 System Voltage		2.5-3.3V		2.5-3.3V

尺寸 Size		1.3 inch IPS		1.3 inch IPS
分辨率 Number of Pixels		240x240		240x240
驱动 Driver IC		ST7789V2		ST7789P3
显示区域 Active Area		23.40x23.40mm		23.40x23.40mm
面板尺寸 Panel Size		26.16x29.22x1.5mm		26.16x29.22x1.5mm
颜色 Color		65K		65K
接口 Interface		4-SPI/8 Bit 8080 MCU		4-SPI/8 Bit 8080 MCU
管脚 Pin		24pins 0.5mm pitch		12pins 0.5mm pitch
系统供电 System Voltage		2.5-3.3V		2.5-3.3V

TFT彩色裸屏 Full Color TFT Screen

1.32~1.44 inch

尺寸 Size		1.32 inch IPS		1.32 inch IPS
分辨率 Number of Pixels		360x360		360x360
驱动 Driver IC		GC9C01		GC9C01
显示区域 Active Area		33.48x35.18mm		33.48x35.18mm
面板尺寸 Panel Size		35.98x38.54x1.56mm		35.98x38.54x1.56mm
颜色 Color		16.7M		262K
接口 Interface		QSPI		MIPI
管脚 Pin		12pins 0.7mm pitch		12pins 0.7mm pitch
系统供电 System Voltage		2.5-3.3V		2.5-3.3V

尺寸 Size		1.42 inch IPS		1.42 inch IPS
分辨率 Number of Pixels		80x160		80x160
驱动 Driver IC		NV3022B3		NV3022B3
显示区域 Active Area		16.176x32.352mm		16.176x32.352mm
面板尺寸 Panel Size		18.08x36.52x2.08mm		18.08x36.52x2.08mm
颜色 Color		262K		262K
接口 Interface		4-SPI		4-SPI
管脚 Pin		12pins 0.7mm pitch		8pins 0.5mm pitch
系统供电 System Voltage		2.5-3.3V		2.5-3.3V

尺寸 Size		1.44 inch		1.44 inch
分辨率 Number of Pixels		128x128		128x128
驱动 Driver IC		ST7735S		ST7735S
显示区域 Active Area		25.5x26.5mm		25.5x26.5mm
面板尺寸 Panel Size		27.9x32.64x2.16mm		27.9x32.64x2.11mm
颜色 Color		262K		262K
接口 Interface		4-SPI		4-SPI
管脚 Pin		12pins 0.7mm pitch		14pins 0.8mm pitch
系统供电 System Voltage		2.5-3.3V		2.5-3.3V



尺寸 Size		1.44 inch		1.44 inch
分辨率 Number of Pixels		128x128		128x128
驱动 Driver IC		ST7735S		ST7735S
显示区域 Active Area		25.5x26.5mm		25.5x26.5mm
面板尺寸 Panel Size		27.9x32.64x2.11mm		29.5x36.5x2.25mm
颜色 Color		262K		262K
接口 Interface		4-SPI		4-SPI
管脚 Pin		8pins 0.5mm pitch		14pins 0.8mm pitch
系统供电 System Voltage		2.5-3.3V		2.7-3.3V

TFT彩色裸屏 Full Color TFT Screen

1.44~1.47 inch

尺寸 Size		1.44 inch		1.44 inch
分辨率 Number of Pixels		128x128		128x128
驱动 Driver IC		ST7735S		ST7735S
显示区域 Active Area		25.5x26.5mm		25.5x26.5mm
面板尺寸 Panel Size		27.90x32.64x2.11mm		29.54x36.5x2.5mm
颜色 Color		262K		65K
接口 Interface		4-SPI		4-SPI
管脚 Pin		14pins 0.5mm pitch		14pins 0.5mm pitch
系统供电 System Voltage		2.5-3.3V		2.8-3.3V

尺寸 Size		1.45 inch		1.45 inch
分辨率 Number of Pixels		60x160		60x160
驱动 Driver IC		GC9107		GC9107
显示区域 Active Area		13.1x34.9mm		13.1x34.9mm
面板尺寸 Panel Size		15.4x39.69x2.1mm		15.4x39.69x2.1mm
颜色 Color		RGB Vvertical stripe		RGB Vvertical stripe
接口 Interface		4-SPI		4-SPI
管脚 Pin		13pins 0.7mm pitch		8pins 0.7mm pitch
系统供电 System Voltage		2.5-3.3V		2.5-3.3V

尺寸 Size		1.45 inch IPS		1.47 inch IPS(HC)
分辨率 Number of Pixels		412x412		172x320
驱动 Driver IC		SPD2010		ST7789P3
显示区域 Active Area		36.96x38.81mm		17.65x32.83mm
面板尺寸 Panel Size		39.36x41.53x1.56mm		19.65x36.76x1.56mm
颜色 Color		RGB Vvertical stripe		262K
接口 Interface		QSPI		4-SPI
管脚 Pin		15pins 0.3mm pitch		12pins 0.7mm pitch
系统供电 System Voltage		2.5-3.3V		2.5-3.3V

尺寸 Size		1.47 inch IPS(HC)		1.47 inch IPS
分辨率 Number of Pixels		172x320		172x320
驱动 Driver IC		ST7789V3		ST7789V3
显示区域 Active Area		17.65x32.83mm		17.39x32.35mm
面板尺寸 Panel Size		19.65x36.76x1.56mm		19.39x36.28x1.46mm
颜色 Color		262K		262K
接口 Interface		4-SPI		4-SPI
管脚 Pin		8pins 0.5mm pitch		12pins 0.7mm pitch
系统供电 System Voltage		2.5-3.3V		2.5-3.3V

TFT彩色裸屏 Full Color TFT Screen

1.47~1.54 inch

尺寸 Size		1.47 inch IPS		1.47 inch IPS
分辨率 Number of Pixels		172x320		172x320
驱动 Driver IC		ST7789V3		GC9307
显示区域 Active Area		17.39x32.35mm		17.65x32.83mm
面板尺寸 Panel Size		19.39x36.28x1.46mm		19.75x36.86x1.56mm
颜色 Color		262K		RGB Vvertical stripe
接口 Interface		4-SPI		SPI
管脚 Pin		8pins 0.5mm pitch		12pins 0.7mm pitch
系统供电 System Voltage		2.5-3.3V		2.4-3.3V

尺寸 Size		1.47 inch IPS		1.50 inch IPS
分辨率 Number of Pixels		172x320		240x280
驱动 Driver IC		GC9307		ST7789P3
显示区域 Active Area		17.65x32.83mm		24.77x28.9mm
面板尺寸 Panel Size		19.75x36.86x1.56mm		26.77x33.45x1.56mm
颜色 Color		RGB Vvertical stripe		262K
接口 Interface		SPI		4-SPI
管脚 Pin		8pins 0.5mm pitch		12pins 0.7mm pitch
系统供电 System Voltage		2.4-3.3V		2.5-3.3V

尺寸 Size		1.54 inch IPS		1.54 inch IPS(JDF)
分辨率 Number of Pixels		240x240		240x240
驱动 Driver IC		GC9307C		ST7789V2
显示区域 Active Area		27.72x27.72mm		27.72x27.72mm
面板尺寸 Panel Size		31.52x33.72x1.87mm		31.52x33.72x1.9mm
颜色 Color		262K		262K
接口 Interface		4-SPI		4-SPI
管脚 Pin		12pins 0.7mm pitch		15pins 0.3mm pitch
系统供电 System Voltage		2.4-3.3V		2.5-3.3V



尺寸 Size		1.54 inch IPS(HC)		1.54 inch IPS(JDF)
分辨率 Number of Pixels		240x240		240x240
驱动 Driver IC		ST7789V3		ST7789V3
显示区域 Active Area		27.72x27.72mm		27.72x27.72mm
面板尺寸 Panel Size		31.52x33.72x1.9mm		31.52x33.72x1.9mm
颜色 Color		262K		262K
接口 Interface		4-SPI		4-SPI
管脚 Pin		12pins 0.7mm pitch		12pins 0.7mm pitch
系统供电 System Voltage		2.5-3.3V		2.5-3.3V

TFT彩色裸屏 Full Color TFT Screen

1.54~1.77 inch

尺寸 Size		1.54 inch IPS		1.54 inch IPS(JDF)
分辨率 Number of Pixels		240x240		240x240
驱动 Driver IC		ST7789V3		ST7789T3
显示区域 Active Area		27.72x27.72mm		27.72x27.72mm
面板尺寸 Panel Size		31.52x33.72x1.9mm		31.52x33.72x1.87mm
颜色 Color		262K		262K
接口 Interface		4-SPI		4-SPI
管脚 Pin		12pins 0.5mm pitch		12pins 0.5mm pitch
系统供电 System Voltage		2.5-3.3V		2.5-3.3V



尺寸 Size		1.54 inch IPS(JDF)		1.65 inch IPS
分辨率 Number of Pixels		240x240		142x428
驱动 Driver IC		ST7789T3		NV3007
显示区域 Active Area		27.72x27.72mm		13.16x39.68mm
面板尺寸 Panel Size		31.52x33.72x1.87mm		16.3x44.96x2.93mm
颜色 Color		262K		RGB Vvertical stripe
接口 Interface		4-SPI		4-SPI
管脚 Pin		12pins 0.7mm pitch		13pins 0.7mm pitch
系统供电 System Voltage		2.5-3.3V		2.5-3.3V



尺寸 Size		1.65 inch IPS		1.69 inch IPS
分辨率 Number of Pixels		142x428		240x280
驱动 Driver IC		NV3007		ST7789V2
显示区域 Active Area		13.16x39.68mm		27.97x32.63mm
面板尺寸 Panel Size		16.3x44.96x2.93mm		30.07x37.43x1.56mm
颜色 Color		RGB Vvertical stripe		262K
接口 Interface		4-SPI		4-SPI
管脚 Pin		8pins 0.5mm pitch		12pins 0.7mm pitch
系统供电 System Voltage		2.5-3.3V		2.5-3.3V



尺寸 Size		1.69 inch IPS		1.77 inch
分辨率 Number of Pixels		240x280		128x160
驱动 Driver IC		ST7789V2		ST7735S
显示区域 Active Area		27.97x32.63mm		28.03x35.04mm
面板尺寸 Panel Size		30.07x37.43x1.56mm		33.60x42.75x2.28mm
颜色 Color		262K		262K
接口 Interface		8Bit 8080 MCU		4-SPI
管脚 Pin		18pins 0.7mm pitch		18pins 0.7mm pitch
系统供电 System Voltage		2.5-3.3V		2.5-3.3V

TFT彩色裸屏 Full Color TFT Screen

1.77~1.80 inch

尺寸 Size		1.77 inch		1.8 inch
分辨率 Number of Pixels		128x160		128x160
驱动 Driver IC		ST7735S		ST7735S
显示区域 Active Area		28.03x35.04mm		28.03x35.04mm
面板尺寸 Panel Size		33.60x42.75x2.28mm		33x45.83x2.2mm
颜色 Color		262K		65K
接口 Interface		4-SPI		4-SPI
管脚 Pin		14pins 0.5mm pitch		14pins 0.5mm pitch
系统供电 System Voltage		2.5-3.3V		2.8-3.3V



尺寸 Size		1.8 inch		1.8 inch
分辨率 Number of Pixels		128x160		128x160
驱动 Driver IC		ST7735S		ST7735S
显示区域 Active Area		28.03x35.04mm		28.03x35.04mm
面板尺寸 Panel Size		34x45.83x2.56mm		34x45.83x2.04mm
颜色 Color		65K		65K
接口 Interface		4-SPI		8Bit 8080 MCU
管脚 Pin		14pins 0.5mm pitch		24pins 0.5mm pitch
系统供电 System Voltage		2.8-3.3V		2.8-3.3V

尺寸 Size		1.8 inch		1.8 inch
分辨率 Number of Pixels		128x160		128x160
驱动 Driver IC		ST7735S		ST7735S
显示区域 Active Area		28.03x35.04mm		28.03x35.04mm
面板尺寸 Panel Size		34x46.7x2.3mm		34x45.83x2.4mm
颜色 Color		262K		65K
接口 Interface		SPI		8Bit 8080 MCU
管脚 Pin		18pins 0.8mm pitch		20pins 1mm pitch
系统供电 System Voltage		2.8-3.3V		2.8-3.3V



尺寸 Size		1.8 inch		1.8 inch
分辨率 Number of Pixels		128x160		128x160
驱动 Driver IC		ST7735S		ST7735S
显示区域 Active Area		28.03x35.04mm		28.03x35.04mm
面板尺寸 Panel Size		34x45.83x2.2mm		34x45.83x2.56mm
颜色 Color		65K		65K
接口 Interface		4-SPI		4-SPI
管脚 Pin		14pins 0.8mm pitch		14pins 0.8mm pitch
系统供电 System Voltage		2.8-3.3V		2.8-3.3V

TFT彩色裸屏 Full Color TFT Screen

1.80~1.90 inch

尺寸 Size		1.8 inch (DRT)		1.83 inch IPS
分辨率 Number of Pixels		128x160		240x280
驱动 Driver IC		ST7735S		ST7789T3
显示区域 Active Area		28.03x35.04mm		30.2x35.23mm
面板尺寸 Panel Size		34x45.83x3.56mm		32.2x39.23x1.46mm
颜色 Color		65K		262K
接口 Interface		4-SPI		3 Line 2 data lane
管脚 Pin		14pins 0.8mm pitch		13pins 0.3mm pitch
系统供电 System Voltage		2.8-3.3V		2.5-3.3V

尺寸 Size		1.83 inch IPS		1.90 inch IPS
分辨率 Number of Pixels		240x280		170x320
驱动 Driver IC		NV3030B		GC9307
显示区域 Active Area		30.2x35.23mm		22.7x42.72mm
面板尺寸 Panel Size		32.2x39.23x1.46mm		25x49.32x1.43mm
颜色 Color		262K		RGB Vvertical stripe
接口 Interface		4-SPI		4-SPI/8Bit 8080 MCU
管脚 Pin		12pins 0.7mm pitch		12pins 0.7mm pitch
系统供电 System Voltage		2.5-3.3V		2.4-3.3V

尺寸 Size		1.90 inch IPS		1.90 inch IPS
分辨率 Number of Pixels		170x320		170x320
驱动 Driver IC		GC9307		GC9307
显示区域 Active Area		22.7x42.72mm		22.7x42.72mm
面板尺寸 Panel Size		25x49.32x1.43mm		25.8x49.32x1.43mm
颜色 Color		RGB Vvertical stripe		RGB Vvertical stripe
接口 Interface		4-SPI/8Bit 8080 MCU		4-SPI/8Bit 8080 MCU
管脚 Pin		12pins 0.5mm pitch		30pins 0.5mm pitch
系统供电 System Voltage		2.4-3.3V		2.4-3.3V

尺寸 Size		1.90 inch IPS JK		1.90 inch IPS TK
分辨率 Number of Pixels		170x320		170x320
驱动 Driver IC		ST7789V3		ST7789V3
显示区域 Active Area		22.695x42.72mm		22.7x42.72mm
面板尺寸 Panel Size		25.8x49.72x1.43mm		25.8x49.32x1.43mm
颜色 Color		262K		262K
接口 Interface		4-SPI/8Bit 8080 MCU		4-SPI/8Bit 8080 MCU
管脚 Pin		30pins 0.5mm pitch		30pins 0.5mm pitch
系统供电 System Voltage		2.4-3.3V		2.4-3.3V

TFT彩色裸屏 Full Color TFT Screen

1.90~2.01 inch

尺寸 Size		1.90 inch IPS		2.0 inch IPS
分辨率 Number of Pixels		170x320		240x320
驱动 Driver IC		ST7789V3		ST7789V2
显示区域 Active Area		22.7x42.72mm		30.6x40.8mm
面板尺寸 Panel Size		25.8x49.32x1.43mm		34.6x47.8x2.05mm
颜色 Color		262K		65K
接口 Interface		4-SPI/8Bit 8080 MCU		4-SPI/8Bit 8080 MCU
管脚 Pin		10pins 0.5mm pitch		22pins 0.5mm pitch
系统供电 System Voltage		2.4-3.3V		2.5-3.3V

尺寸 Size		2.0 inch IPS		2.0 inch IPS
分辨率 Number of Pixels		240x320		240x320
驱动 Driver IC		ST7789V2		ST7789V2
显示区域 Active Area		30.6x40.8mm		30.6x40.8mm
面板尺寸 Panel Size		34.6x47.8x2.05mm		34.6x47.8x2.05mm
颜色 Color		262K		262K
接口 Interface		8Bit 8080 MCU		4-SPI
管脚 Pin		22pins 0.5mm pitch		14pins 0.5mm pitch
系统供电 System Voltage		2.5-3.3V		2.4-3.3V

尺寸 Size		2.0 inch IPS		2.0 inch IPS
分辨率 Number of Pixels		240x320		240x320
驱动 Driver IC		GC9307		GC9307
显示区域 Active Area		30.6x40.8mm		30.6x40.8mm
面板尺寸 Panel Size		34.6x47.8x1.960mm		34.6x47.8x1.960mm
颜色 Color		262K		262K
接口 Interface		4-SPI		4-SPI
管脚 Pin		12pins 0.8mm pitch		22pins 0.5mm pitch
系统供电 System Voltage		2.4-3.3V		2.4-3.3V



尺寸 Size		2.0 inch IPS		2.01 inch IPS
分辨率 Number of Pixels		240x320		240x296
驱动 Driver IC		ST7789V2		NV3031A-AI
显示区域 Active Area		30.6x40.8mm		32.04x39.51mm
面板尺寸 Panel Size		34.6x47.8x1.960mm		34.04x43.32x1.86mm
颜色 Color		65K		262K
接口 Interface		4-SPI		4-SPI
管脚 Pin		22pins 0.5mm pitch		10pins 0.8mm pitch
系统供电 System Voltage		2.5-3.3V		2.5-3.3V

TFT彩色裸屏 Full Color TFT Screen

2.01~2.76 inch

尺寸 Size		2.01 inch IPS		2.01 inch IPS
分辨率 Number of Pixels		240x296		240x296
驱动 Driver IC		ST7789P3		ST7789P3
显示区域 Active Area		32.04x39.51mm		32.04x39.51mm
面板尺寸 Panel Size		34.04x43.32x1.86mm		34.04x43.32x1.86mm
颜色 Color		262K		262K
接口 Interface		4-SPI		4-SPI
管脚 Pin		10pins 0.5mm pitch		8pins 0.5mm pitch
系统供电 System Voltage		2.5-3.3V		2.5-3.3V



尺寸 Size		2.08 inch IPS		2.08 inch IPS
分辨率 Number of Pixels		128x160		128x160
驱动 Driver IC		NV3023B		NV3023B
显示区域 Active Area		31.87x39.84mm		31.87x39.84mm
面板尺寸 Panel Size		37.27x47.24x2.27mm		37.27x47.24x2.27mm
颜色 Color		262K		262K
接口 Interface		4-SPI		4-SPI
管脚 Pin		13pins 0.7mm pitch		8pins 0.5mm pitch
系统供电 System Voltage		2.5-3.3V		2.5-3.3V

尺寸 Size		2.1 inch ISP		2.25 inch
分辨率 Number of Pixels		480x480		76x284
驱动 Driver IC		ST7701S		ST7789P3
显示区域 Active Area		53.28x53.28 mm		14.797x55.295mm
面板尺寸 Panel Size		56.18x59.71x2.30mm		17.9x62.5x2.36mm
颜色 Color		262K		262K
接口 Interface		3-SPI+18RGB		4-SPI
管脚 Pin		40pins 0.5mm pitch		8pins 0.5mm pitch
系统供电 System Voltage		2.5-4.8V		2.5-3.3V

尺寸 Size		2.25 inch		2.76 inch IPS
分辨率 Number of Pixels		76x284		480x480
驱动 Driver IC		ST7789P3		ST7701S
显示区域 Active Area		14.797x55.295mm		70.13x70.13 mm
面板尺寸 Panel Size		17.9x62.5x2.36mm		73.03x76.48x2.34mm
颜色 Color		262K		262K
接口 Interface		4-SPI		3-SPI+18RGB
管脚 Pin		10pins 0.6mm pitch		40pins 0.5mm pitch
系统供电 System Voltage		2.5-3.3V		2.5-3.3V

TFT彩色裸屏 Full Color TFT Screen

2.79~2.80 inch

尺寸 Size		2.79 inch		2.80 inch IPS
分辨率 Number of Pixels		142x428		240x320
驱动 Driver IC		NV3007A		ST7789
显示区域 Active Area		21.28x64.14 mm		43.20x57.6mm
面板尺寸 Panel Size		24.38x69.43x2.1mm		50x69.20x2.25mm
颜色 Color		262K		262K
接口 Interface		4-SPI		4-SPI
管脚 Pin		10pins 0.5mm pitch		12pins 0.8mm pitch
系统供电 System Voltage		2.5-3.3V		2.5-3.3V

尺寸 Size		2.80 inch IPS		2.80 inch IPS
分辨率 Number of Pixels		240x320		240x320
驱动 Driver IC		ST7789		ST7789
显示区域 Active Area		43.20x57.6mm		43.20x57.6mm
面板尺寸 Panel Size		50x69.20x2.25mm		50x69.20x2.25mm
颜色 Color		262K		262K
接口 Interface		4-SPI		4-SPI/8Bit 8080 MCU
管脚 Pin		14pins 0.5mm pitch		22pins 0.5mm pitch
系统供电 System Voltage		2.5-3.3V		2.5-3.3V

尺寸 Size		2.80 inch IPS		2.80 inch IPS
分辨率 Number of Pixels		240x320		240x320
驱动 Driver IC		ST7789V		ST7789V
显示区域 Active Area		43.20x57.6mm		43.20x57.60mm
面板尺寸 Panel Size		47.8x66.95x2.13mm		47.8x66.95x2.13mm
颜色 Color		65K		65K
接口 Interface		4-SPI		SPI/MCU-8/MCU-16
管脚 Pin		10pins 0.5mm pitch		40pins 0.5mm pitch
系统供电 System Voltage		2.8-3.3V		2.8-3.3V



尺寸 Size		2.80 inch IPS(DCT)		2.80 inch IPS
分辨率 Number of Pixels		240x320		240x320
驱动 Driver IC		ST7789V		ST7789V
显示区域 Active Area		43.20x57.60mm		43.20x57.60mm
面板尺寸 Panel Size		47.8x66.95x3.56mm		47.8x66.95x2.13mm
颜色 Color		65K		65K
接口 Interface		SPI/MCU-8/MCU-16		MCU-16
管脚 Pin		40pins 0.5mm pitch		37pins 1mm pitch
系统供电 System Voltage		2.8-3.3V		2.8-3.3V

TFT彩色裸屏 Full Color TFT Screen

2.80~2.80 inch

尺寸 Size		2.80 inch IPS(DCT)		2.80 inch IPS
分辨率 Number of Pixels		240x320		240x320
驱动 Driver IC		ST7789V		ST7789V
显示区域 Active Area		43.20x57.60mm		43.20x57.60mm
面板尺寸 Panel Size		47.8x66.95x3.56mm		47.8x66.95x2.13mm
颜色 Color		65K		65K
接口 Interface		MCU-16		4-SPI
管脚 Pin		37pins 1mm pitch		18pins 0.5mm pitch
系统供电 System Voltage		2.8-3.3V		2.8-3.3V

尺寸 Size		2.80 inch IPS(DCT)		2.80 inch
分辨率 Number of Pixels		240x320		240x320
驱动 Driver IC		ST7789V		ST7789/ILI9341
显示区域 Active Area		43.20x57.60mm		43.20x57.60mm
面板尺寸 Panel Size		47.8x66.95x3.56mm		50x69.2x2.6mm
颜色 Color		65K		65K
接口 Interface		4-SPI		SPI/MCU-8/MCU-16
管脚 Pin		18pins 0.5mm pitch		37pins 1mm pitch
系统供电 System Voltage		2.8-3.3V		2.8-3.3V

尺寸 Size		2.80 inch (DRT)		2.80 inch (DCT)
分辨率 Number of Pixels		240x320		240x320
驱动 Driver IC		ST7789/ILI9341V		ST7789/ILI9341V
显示区域 Active Area		43.20x57.60mm		43.20x57.60mm
面板尺寸 Panel Size		50x69.2x3.8mm		50x69.2x4.08mm
颜色 Color		65K		65K
接口 Interface		SPI/MCU-8/MCU-16		SPI/MCU-8/MCU-16
管脚 Pin		37pins 1mm pitch		37pins 1mm pitch
系统供电 System Voltage		2.8-3.3V		2.8-3.3V

尺寸 Size		2.80 inch		2.80 inch (DRT)
分辨率 Number of Pixels		240x320		240x320
驱动 Driver IC		ST7789/ILI9341V		ST7789/ILI9341V
显示区域 Active Area		43.20x57.60mm		43.20x57.60mm
面板尺寸 Panel Size		50x69.2x2.6mm		50x69.2x3.8mm
颜色 Color		65K		65K
接口 Interface		SPI/MCU-8/MCU-16		SPI/MCU-8/MCU-16
管脚 Pin		40pins 0.5mm pitch		40pins 0.5mm pitch
系统供电 System Voltage		2.8-3.3V		2.8-3.3V

TFT彩色裸屏 Full Color TFT Screen

2.80~3.20 inch

尺寸 Size		2.80 inch (DCT)		2.80 inch
分辨率 Number of Pixels		240x320		240x320
驱动 Driver IC		ST7789/ILI9341V		ST7789/ILI9341V
显示区域 Active Area		43.20x57.60mm		43.20x57.60mm
面板尺寸 Panel Size		50x69.2x4.08mm		50x69.2x2.6mm
颜色 Color		65K		65K
接口 Interface		SPI/MCU-8/MCU-16		4-SPI
管脚 Pin		40pins 0.5mm pitch		18pins 0.8mm pitch
系统供电 System Voltage		2.8-3.3V		2.8-3.3V



尺寸 Size		2.80 inch(DRT)		2.80 inch(DCT)
分辨率 Number of Pixels		240x320		240x320
驱动 Driver IC		ST7789/ILI9341V		ST7789/ILI9341V
显示区域 Active Area		43.20x57.60mm		43.20x57.60mm
面板尺寸 Panel Size		50x69.2x3.8mm		50x69.2x4.08mm
颜色 Color		65K		65K
接口 Interface		4-SPI		4-SPI
管脚 Pin		18pins 0.8mm pitch		18pins 0.8mm pitch
系统供电 System Voltage		2.8-3.3V		2.8-3.3V

尺寸 Size		2.80 inch		2.80 inch(DRT)
分辨率 Number of Pixels		240x320		240x320
驱动 Driver IC		ST7789/ILI9341V		ST7789/ILI9341V
显示区域 Active Area		43.20x57.60mm		43.20x57.60mm
面板尺寸 Panel Size		50x69.2x2.6mm		50x69.2x3.8mm
颜色 Color		65K		65K
接口 Interface		4-SPI		4-SPI
管脚 Pin		18pins 0.5mm pitch		18pins 0.5mm pitch
系统供电 System Voltage		2.8-3.3V		2.8-3.3V

尺寸 Size		2.80 inch(DCT)		3.2 inch
分辨率 Number of Pixels		240x320		240x320
驱动 Driver IC		ST7789/ILI9341V		ST7789/ILI9341V
显示区域 Active Area		43.20x57.60mm		48.6x64.8mm
面板尺寸 Panel Size		50x69.2x4.08mm		54x77.4x2.4mm
颜色 Color		65K		65K
接口 Interface		4-SPI		4-SPI
管脚 Pin		18pins 0.5mm pitch		18pins 0.5mm pitch
系统供电 System Voltage		2.8-3.3V		2.8-3.3V

TFT彩色裸屏 Full Color TFT Screen

3.20~3.20 inch

尺寸 Size		3.2 inch(DRT)		3.2 inch(DCT)
分辨率 Number of Pixels		240x320		240x320
驱动 Driver IC		ST7789/ILI9341V		ST7789/ILI9341V
显示区域 Active Area		48.6x64.8mm		48.6x64.8mm
面板尺寸 Panel Size		54x77.4x3.7mm		54x77.4x3.88mm
颜色 Color		65K		65K
接口 Interface		4-SPI		4-SPI
管脚 Pin		18pins 0.5mm pitch		18pins 0.5mm pitch
系统供电 System Voltage		2.8-3.3V		2.8-3.3V

尺寸 Size		3.2 inch		3.2 inch(DRT)
分辨率 Number of Pixels		240x320		240x320
驱动 Driver IC		ST7789/ILI9341V		ST7789/ILI9341V
显示区域 Active Area		48.6x64.8mm		48.6x64.8mm
面板尺寸 Panel Size		54x77.4x2.4mm		54x77.4x3.7mm
颜色 Color		65K		65K
接口 Interface		4-SPI		4-SPI
管脚 Pin		18pins 0.8mm pitch		18pins 0.8mm pitch
系统供电 System Voltage		2.8-3.3V		2.8-3.3V



尺寸 Size		3.2 inch(DCT)		3.2 inch
分辨率 Number of Pixels		240x320		240x320
驱动 Driver IC		ST7789/ILI9341V		ST7789/ILI9341V
显示区域 Active Area		48.6x64.8mm		48.6x64.8mm
面板尺寸 Panel Size		54x77.4x3.88mm		54x77.4x2.4mm
颜色 Color		65K		65K
接口 Interface		4-SPI		SPI/MCU-8/MCU-16
管脚 Pin		18pins 0.8mm pitch		40pins 0.5mm pitch
系统供电 System Voltage		2.8-3.3V		2.8-3.3V



尺寸 Size		3.2 inch(DRT)		3.2 inch(DCT)
分辨率 Number of Pixels		240x320		240x320
驱动 Driver IC		ST7789/ILI9341V		ST7789/ILI9341V
显示区域 Active Area		48.6x64.8mm		48.6x64.8mm
面板尺寸 Panel Size		54x77.4x3.7mm		54x77.4x3.88mm
颜色 Color		65K		65K
接口 Interface		SPI/MCU-8/MCU-16		SPI/MCU-8/MCU-16
管脚 Pin		40pins 0.5mm pitch		40pins 0.5mm pitch
系统供电 System Voltage		2.8-3.3V		2.8-3.3V



TFT彩色裸屏 Full Color TFT Screen

3.20~3.50 inch

尺寸 Size		3.2 inch		3.2 inch(DRT)
分辨率 Number of Pixels		240x320		240x320
驱动 Driver IC		ST7789/ILI9341V		ST7789/ILI9341V
显示区域 Active Area		48.6x64.8mm		48.6x64.8mm
面板尺寸 Panel Size		54x77.4x2.4mm		54x77.4x3.7mm
颜色 Color		65K		65K
接口 Interface		MCU-8/MCU-16		MCU-8/MCU-16
管脚 Pin		37pins 1mm pitch		37pins 1mm pitch
系统供电 System Voltage		2.8-3.3V		2.8-3.3V

尺寸 Size		3.2 inch(DCT)		3.5 inch IPS
分辨率 Number of Pixels		240x320		320x480
驱动 Driver IC		ST7789/ILI9341V		ST7796U
显示区域 Active Area		48.6x64.8mm		48.96x73.44mm
面板尺寸 Panel Size		54x77.4x3.88mm		55.26x84.52x3.83mm
颜色 Color		65K		65K
接口 Interface		MCU-8/MCU-16		SPI/MCU-8/MCU-16
管脚 Pin		37pins 1mm pitch		32pins 0.5mm pitch
系统供电 System Voltage		2.8-3.3V		2.8-3.3V

尺寸 Size		3.5 inch IPS (DCT)		3.5 inch
分辨率 Number of Pixels		320x480		320x480
驱动 Driver IC		ST7796U		ST7796/ILI9488
显示区域 Active Area		48.96x73.44mm		48.96x73.44mm
面板尺寸 Panel Size		55.26x84.52x4.13mm		55.26x84.52x2.7mm
颜色 Color		65K		65K
接口 Interface		SPI/MCU-8/MCU-16		SPI/MCU-8/MCU-16
管脚 Pin		32pins 0.5mm pitch		40pins 0.5mm pitch
系统供电 System Voltage		2.8-3.3V		2.8-3.3V

尺寸 Size		3.5 inch(DRT)		3.5 inch(DCT)
分辨率 Number of Pixels		320x480		320x480
驱动 Driver IC		ST7796/ILI9488		ST7796/ILI9488
显示区域 Active Area		48.96x73.44mm		48.96x73.44mm
面板尺寸 Panel Size		55.26x84.52x4.0mm		55.26x84.52x4.13mm
颜色 Color		65K		65K
接口 Interface		SPI/MCU-8/MCU-16		SPI/MCU-8/MCU-16
管脚 Pin		40pins 0.5mm pitch		40pins 0.5mm pitch
系统供电 System Voltage		2.8-3.3V		2.8-3.3V

TFT彩色裸屏 Full Color TFT Screen

3.50~3.50 inch

尺寸 Size		3.5 inch IPS		3.5 inch IPS(DCT)
分辨率 Number of Pixels		320x480		320x480
驱动 Driver IC		ST7796U		ST7796U
显示区域 Active Area		48.96x73.44mm		48.96x73.44mm
面板尺寸 Panel Size		55.26x84.52x2.4mm		55.26x84.52x3.83mm
颜色 Color		65K		65K
接口 Interface		SPI/MCU-8/MCU-16		SPI/MCU-8/MCU-16
管脚 Pin		32pins 0.5mm pitch		32pins 0.5mm pitch
系统供电 System Voltage		2.8-3.3V		2.8-3.3V

尺寸 Size		3.5 inch IPS		3.5 inch IPS(DCT)
分辨率 Number of Pixels		320x480		320x480
驱动 Driver IC		ST7796U		ST7796U
显示区域 Active Area		48.96x73.44mm		48.96x73.44mm
面板尺寸 Panel Size		55.26x84.52x2.4mm		55.26x84.52x2.4mm
颜色 Color		65K		65K
接口 Interface		SPI/MCU-8/MCU-16		SPI/MCU-8/MCU-16
管脚 Pin		40pins 0.5mm pitch		40pins 0.5mm pitch
系统供电 System Voltage		2.8-3.3V		2.8-3.3V

尺寸 Size		3.5 inch IPS		3.5 inch IPS(DCT)
分辨率 Number of Pixels		320x480		320x480
驱动 Driver IC		ST7796U		ST7796U
显示区域 Active Area		48.96x73.44mm		48.96x73.44mm
面板尺寸 Panel Size		55.26x84.52x2.4mm		55.26x84.52x2.4mm
颜色 Color		65K		65K
接口 Interface		MCU-16		MCU-16
管脚 Pin		37pins 1mm pitch		37pins 1mm pitch
系统供电 System Voltage		2.8-3.3V		2.8-3.3V



尺寸 Size		3.5 inch		3.5 inch (DRT)
分辨率 Number of Pixels		320x480		320x480
驱动 Driver IC		ST7796/ILI9488		ST7796/ILI9488
显示区域 Active Area		48.96x73.44mm		48.96x73.44mm
面板尺寸 Panel Size		55.26x84.52x2.7mm		55.26x84.52x4.0mm
颜色 Color		65K		65K
接口 Interface		MCU-16		MCU-16
管脚 Pin		37pins 1mm pitch		37pins 1mm pitch
系统供电 System Voltage		2.8-3.3V		2.8-3.3V

TFT彩色裸屏 Full Color TFT Screen

3.50~4.00 inch

尺寸 Size		3.5 inch (DCT)		3.97 inch IPS (DCT)
分辨率 Number of Pixels		320x480		480x800
驱动 Driver IC		ST7796/ILI9488		ST7701
显示区域 Active Area		48.96x73.44mm		51.84x86.40mm
面板尺寸 Panel Size		55.26x84.52x4.13mm		55.94x94.95x2.03mm
颜色 Color		65K		65k
接口 Interface		MCU-16		3-SPI+16 bit RGB
管脚 Pin		37pins 1mm pitch		33pins 0.3mm pitch
系统供电 System Voltage		2.8-3.3V		2.5-3.3V



尺寸 Size		4.0 inch		4.0 inch (DRT)
分辨率 Number of Pixels		320x480		320x480
驱动 Driver IC		ILI9488		ILI9488
显示区域 Active Area		55.68x83.52mm		55.68x83.52mm
面板尺寸 Panel Size		60.88x94.57x2.65mm		60.88x94.57x3.65mm
颜色 Color		65K		65K
接口 Interface		MCU-8/MCU-16		MCU-8/MCU-16
管脚 Pin		39pins 0.8mm pitch		39pins 0.8mm pitch
系统供电 System Voltage		2.8-3.3V		2.8-3.3V

尺寸 Size		4.0 inch(DCT)		4.0 inch
分辨率 Number of Pixels		320x480		320x480
驱动 Driver IC		ILI9488		ST7796U
显示区域 Active Area		55.68x83.52mm		55.68x83.52mm
面板尺寸 Panel Size		60.88x94.57x4.08mm		60.88x94.57x2.65mm
颜色 Color		65K		65K
接口 Interface		MCU-8/MCU-16		MCU-8/MCU-16
管脚 Pin		39pins 0.8mm pitch		37pins 1mm pitch
系统供电 System Voltage		2.8-3.3V		2.8-3.3V

尺寸 Size		4.0 inch(DRT)		4.0 inch(DCT)
分辨率 Number of Pixels		320x480		320x480
驱动 Driver IC		ST7796U		ST7796U
显示区域 Active Area		55.68x83.52mm		55.68x83.52mm
面板尺寸 Panel Size		60.88x94.57x3.65mm		60.88x94.57x4.08mm
颜色 Color		65K		65K
接口 Interface		MCU-8/MCU-16		MCU-8/MCU-16
管脚 Pin		37pins 1mm pitch		37pins 1mm pitch
系统供电 System Voltage		2.8-3.3V		2.8-3.3V

TFT彩色裸屏 Full Color TFT Screen

4.00~4.30 inch

尺寸 Size		4.0 inch		4.0 inch (DRT)
分辨率 Number of Pixels		320x480		320x480
驱动 Driver IC		ST7796/ILI9488		ST7796/ILI9488
显示区域 Active Area		55.68x83.52mm		55.68x83.52mm
面板尺寸 Panel Size		60.88x94.57x2.65mm		60.88x94.57x3.85mm
颜色 Color		65K		65K
接口 Interface		SPI/MCU-8/MCU-16		SPI/MCU-8/MCU-16
管脚 Pin		40pins 0.5mm pitch		40pins 0.5mm pitch
系统供电 System Voltage		2.8-3.3V		2.8-3.3V

尺寸 Size		4.0 inch (DCT)		4.0 inch IPS
分辨率 Number of Pixels		320x480		480x480
驱动 Driver IC		ST7796/ILI9488		ST7701S
显示区域 Active Area		55.68x83.52mm		71.86x70.18mm
面板尺寸 Panel Size		60.88x94.57x4.08mm		74.83x78.96x1.92mm
颜色 Color		65K		262K
接口 Interface		SPI/MCU-8/MCU-16		3-SPI+RGB
管脚 Pin		40pins 0.5mm pitch		40pins 0.5mm pitch
系统供电 System Voltage		2.8-3.3V		2.8-3.6V

尺寸 Size		4.0 inch IPS (DCT)		4.0 inch IPS
分辨率 Number of Pixels		480x480		720x720
驱动 Driver IC		ST7701S		NV3052CGRB
显示区域 Active Area		71.86x70.18mm		71.93x71.93mm
面板尺寸 Panel Size		74.83x78.96x3.05mm		74.83x78.98x2.07mm
颜色 Color		262K		262K
接口 Interface		3-SPI+RGB		RGB-18 BITS
管脚 Pin		40pins 0.5mm pitch		40pins 0.5mm pitch
系统供电 System Voltage		2.8-3.6V		2.5-3.6V

尺寸 Size		4.0 inch IPS(DCT)		4.3 inch IPS
分辨率 Number of Pixels		720x720		480x272
驱动 Driver IC		NV3052CGRB		ST6201
显示区域 Active Area		71.93x71.93mm		95.04x53.86mm
面板尺寸 Panel Size		84x84x3.20mm		105.5x67.2x2.78mm
颜色 Color		262K		65K
接口 Interface		RGB-18 BITS		SPI,MCU8/16,高/双通 SPI
管脚 Pin		40pins 0.5mm pitch		40pins 0.5mm pitch
系统供电 System Voltage		2.5-3.6V		2.8-3.3V

TFT彩色裸屏 Full Color TFT Screen

4.30~5.00 inch

尺寸 Size		4.3 inch IPS(DRT)		4.3 inch IPS (DCT)
分辨率 Number of Pixels		480x272		480x272
驱动 Driver IC		ST6201		ST6201
显示区域 Active Area		95.04x53.86mm		95.04x53.86mm
面板尺寸 Panel Size		105.5x67.2x3.88mm		105.5x67.2x4.22mm
颜色 Color		65K		65K
接口 Interface		SPI,MCU8/16,高/双通SPI		SPI,MCU8/16,高/双通SPI
管脚 Pin		40pins 0.5mm pitch		40pins 0.5mm pitch
系统供电 System Voltage		2.8-3.3V		2.8-3.3V

尺寸 Size		4.3 inch IPS		4.3 inch IPS(DRT)
分辨率 Number of Pixels		480x272		480x272
驱动 Driver IC		NV3047		NV3047
显示区域 Active Area		95.04x53.86mm		95.04x53.86mm
面板尺寸 Panel Size		105.42x67.07x3mm		105.42x67.07x4.2mm
颜色 Color		16M		16M
接口 Interface		RGB		RGB
管脚 Pin		40pins 0.5mm pitch		40pins 0.5mm pitch
系统供电 System Voltage		2.8-3.3V		2.8-3.3V



尺寸 Size		4.3 inch IPS(DCT)		5.0 inch IPS
分辨率 Number of Pixels		480x272		480x854
驱动 Driver IC		NV3047		ST7701S
显示区域 Active Area		95.04x53.86mm		61.63x109.65mm
面板尺寸 Panel Size		105.42x67.07x4.2mm		67.56x122.35x2.22mm
颜色 Color		16M		65K
接口 Interface		RGB		RGB(TTL)
管脚 Pin		40pins 0.5mm pitch		40pins 0.5mm pitch
系统供电 System Voltage		2.8-3.3V		2.8-3.3V



尺寸 Size		5.0 inch IPS(DCT)		5.0 inch IPS(DCT)
分辨率 Number of Pixels		480x854		480x854
驱动 Driver IC		ST7701S		ST7701S
显示区域 Active Area		61.63x109.65mm		61.63x109.65mm
面板尺寸 Panel Size		67.56x122.35x2.22mm		79.5x139.5x3.57mm
颜色 Color		65K		65K
接口 Interface		RGB(TTL)		RGB(TTL)
管脚 Pin		40pins 0.5mm pitch		40pins 0.5mm pitch
系统供电 System Voltage		2.8-3.3V		2.8-3.3V

TFT彩色裸屏 Full Color TFT Screen



5.00~10.1 inch

尺寸 Size		5.0 inch IPS		5.0 inch IPS
分辨率 Number of Pixels		800x480		800x480
驱动 Driver IC		ST7701S		ST7701S
显示区域 Active Area		108x64.8mm		108x64.8mm
面板尺寸 Panel Size		120.7x75.8x3mm		120.7x75.8x3mm
颜色 Color		16M		16M
接口 Interface		RGB		RGB
管脚 Pin		40pins 0.5mm pitch		40pins 0.5mm pitch
系统供电 System Voltage		2.8-3.3V		2.8-3.3V



尺寸 Size		7.0 inch IPS		7.0 inch IPS
分辨率 Number of Pixels		1024x600		1024x600
驱动 Driver IC		-----		-----
显示区域 Active Area		154.08x85.92mm		154.08x85.92mm
面板尺寸 Panel Size		165x100x3.5mm		165x100x3.5mm
颜色 Color		16M		16M
接口 Interface		RGB 24-bit		RGB 24-bit
管脚 Pin		50pins 0.5mm pitch		50pins 0.5mm pitch
系统供电 System Voltage		2.8-3.3V		2.8-3.3V

尺寸 Size		7.0 inch IPS		10.1 inch IPS
分辨率 Number of Pixels		1024x600		1024x600
驱动 Driver IC		-----		HX8282+HX8696
显示区域 Active Area		154.08x85.92mm		222.72x125.28mm
面板尺寸 Panel Size		176.8x100x3.5mm		235x143x5.0mm
颜色 Color		16M		16.7M
接口 Interface		RGB 24-bit		RGB 24-bit
管脚 Pin		50pins 0.5mm pitch		50pins 0.5mm pitch
系统供电 System Voltage		2.8-3.3V		2.5-3.3V

尺寸 Size		10.1 inch IPS		10.1 inch IPS
分辨率 Number of Pixels		1024x600		1024x600
驱动 Driver IC		HX8282+HX8696		HX8282+HX8696
显示区域 Active Area		222.72x125.28mm		222.72x125.28mm
面板尺寸 Panel Size		235x143x6.5mm		235x143x6.5mm
颜色 Color		16.7M		16.7M
接口 Interface		RGB 24-bit		RGB 24-bit
管脚 Pin		50pins 0.5mm pitch		50pins 0.5mm pitch
系统供电 System Voltage		2.5-3.3V		2.5-3.3V

尺寸 Size		1.54 inch		1.54 inch
分辨率 Number of Pixels		152x152		152x152
驱动 Driver IC		SSD1680		SSD1680
显示区域 Active Area		27.512x27.512mm		27.512x27.512mm
面板尺寸 Panel Size		31.8x37.32x1.0mm		31.8x37.32x1.0mm
颜色 Color		(White+Black)		(White+Black+Red)
接口 Interface		SPI		SPI
管脚 Pin		24pins 0.5mm pitch		24pins 0.5mm pitch
系统供电 System Voltage		2.8-3.3V		2.8-3.3V



尺寸 Size		1.54 inch		2.13 inch
分辨率 Number of Pixels		200x200		122x250
驱动 Driver IC		SSD1681		SSD1680Z
显示区域 Active Area		27.512x27.512mm		23.7046x48.55mm
面板尺寸 Panel Size		31.8x37.32x0.98mm		29.2x59.2x1.0mm
颜色 Color		(White+Black)		(White+Black)
接口 Interface		SPI		SPI
管脚 Pin		24pins 0.5mm pitch		24pins 0.5mm pitch
系统供电 System Voltage		2.8-3.3V		2.8-3.3V

尺寸 Size		2.13 inch		2.13 inch
分辨率 Number of Pixels		122x250		122x250
驱动 Driver IC		SSD1680Z		SSD1680Z
显示区域 Active Area		23.7046x48.55mm		23.7046x48.55mm
面板尺寸 Panel Size		29.2x59.2x1.0mm		29.2x59.2x1.0mm
颜色 Color		(White+Black+Red)		White+Black+Red+Yellow
接口 Interface		SPI		SPI
管脚 Pin		24pins 0.5mm pitch		24pins 0.5mm pitch
系统供电 System Voltage		2.8-3.3V		2.8-3.3V



尺寸 Size		2.66 inch		2.66 inch
分辨率 Number of Pixels		296x152		296x152
驱动 Driver IC		SSD1680/JD79661AA		SSD1680/JD79661AA
显示区域 Active Area		30.704x60.088mm		30.704x60.088mm
面板尺寸 Panel Size		36.3x71.82x1.0mm		36.3x71.82x1.0mm
颜色 Color		(White+Black)		(White+Black+Red)
接口 Interface		SPI		SPI
管脚 Pin		24pins 0.5mm pitch		24pins 0.5mm pitch
系统供电 System Voltage		2.8-3.3V		2.8-3.3V



墨水屏/电子纸 Ink Screen/Electronic Paper

1.54~2.66 inch



尺寸 Size		2.66 inch		2.90 inch
分辨率 Number of Pixels		296x152		296x128
驱动 Driver IC		SSD1680/JD79661AA		SSD1680Z
显示区域 Active Area		30.704×60.088mm		29.056×66.896mm
面板尺寸 Panel Size		36.3×71.82×1.0mm		36.7×79×1.2mm
颜色 Color		White+Black+Red+Yellow		(White+Black)
接口 Interface		SPI		SPI
管脚 Pin		24pins 0.5mm pitch		24pins 0.5mm pitch
系统供电 System Voltage	2.8-3.3V	2.8-3.3V		



尺寸 Size		2.90 inch		3.52 inch
分辨率 Number of Pixels		296x128		180x384
驱动 Driver IC		SSD1680Z		JD79667
显示区域 Active Area		29.056×66.896mm		37.98×81.02mm
面板尺寸 Panel Size		36.7×79×1.2mm		43.98×93.42×1.0mm
颜色 Color		(White+Black+Red)		White+Black+Red+Yellow
接口 Interface		SPI		SPI
管脚 Pin		24pins 0.5mm pitch		24pins 0.5mm pitch
系统供电 System Voltage	2.8-3.3V	2.8-3.3V		



尺寸 Size		3.7 inch		3.7 inch
分辨率 Number of Pixels		240x416		240x416
驱动 Driver IC		UC8253		UC8253
显示区域 Active Area		47.04x81.54mm		47.04x81.54mm
面板尺寸 Panel Size		53.0×92.99×1.0mm		53.0×92.99×1.0mm
颜色 Color		(White+Black)		(White+Black+Red)
接口 Interface		SPI		SPI
管脚 Pin		24pins 0.5mm pitch		24pins 0.5mm pitch
系统供电 System Voltage	2.8-3.3V	2.8-3.3V		

尺寸 Size		3.7 inch		3.97 inch
分辨率 Number of Pixels		240x416		480x800
驱动 Driver IC		SEE420		SE8420(SSD2677ZB)
显示区域 Active Area		47.04x81.54mm		47.04x81.54mm
面板尺寸 Panel Size		53.0×92.99×1.0mm		53.0×92.99×1.0mm
颜色 Color		White+Black+Red+Yellow		White+Black+Red+Yellow
接口 Interface		SPI		SPI
管脚 Pin		24pins 0.8mm pitch		24pins 0.8mm pitch
系统供电 System Voltage	2.8-3.3V	2.8-3.3V		

尺寸 Size		4.20 inch		4.20 inch
分辨率 Number of Pixels		400x300		400x300
驱动 Driver IC		SSD1683		SSD1683
显示区域 Active Area		84.80x63.60mm		84.80x63.60mm
面板尺寸 Panel Size		91x77x1.2mm		91x77x1.2mm
颜色 Color		(White+Black)		(White+Black+Red)
接口 Interface		SPI		SPI
管脚 Pin		24pins 0.5mm pitch		24pins 0.5mm pitch
系统供电 System Voltage	2.8-3.3V	2.8-3.3V	2.8-3.3V	

尺寸 Size		5.79 inch		5.79 inch
分辨率 Number of Pixels		272x792		272x792
驱动 Driver IC		SSD1683*2		SSD1683*2
显示区域 Active Area		47.74x139mm		47.74x139mm
面板尺寸 Panel Size		56.94x150.92x1mm		56.94x150.92x1mm
颜色 Color		(White+Black)		(White+Black+Red)
接口 Interface		SPI		SPI
管脚 Pin		24pins 0.5mm pitch		24pins 0.5mm pitch
系统供电 System Voltage	2.8-3.3V	2.8-3.3V	2.8-3.3V	

尺寸 Size		5.79 inch		5.83 inch
分辨率 Number of Pixels		272x792		648x480
驱动 Driver IC		HX8717*2		UC8179
显示区域 Active Area		47.74x139mm		118.78x88.22mm
面板尺寸 Panel Size		56.94x150.92x1mm		125.4x99.5x1.2mm
颜色 Color		White+Black+Red+Yellow		(White+Black)
接口 Interface		SPI		SPI
管脚 Pin		24pins 0.5mm pitch		24pins 0.5mm pitch
系统供电 System Voltage	2.8-3.3V	2.8-3.3V	2.8-3.3V	

尺寸 Size		5.83 inch		7.5 inch
分辨率 Number of Pixels		648x480		800x480
驱动 Driver IC		UC8179		UC8179
显示区域 Active Area		118.78x88.22mm		163.2x97.92mm
面板尺寸 Panel Size		125.4x99.5x1.2mm		170.2x111.2x1.25mm
颜色 Color		(White+Black+Red)		(White+Black)
接口 Interface		SPI		SPI
管脚 Pin		24pins 0.5mm pitch		24pins 0.5mm pitch
系统供电 System Voltage	2.8-3.3V	2.8-3.3V	2.8-3.3V	

墨水屏 / 电子纸 Ink Screen / Electronic Paper

7.50~7.50 inch

尺寸 Size		7.5 inch	
分辨率 Number of Pixels		800x480	
驱动 Driver IC		UC8179	
显示区域 Active Area		163.2x97.92mm	
面板尺寸 Panel Size		170.2x111.2x1.25mm	
颜色 Color		(White+Black+Red)	
接口 Interface		SPI	
管脚 Pin		24pins 0.5mm pitch	
系统供电 System Voltage		2.8-3.3V	

单色字符屏 Monochrome Character OLED Screen

2.26~5.80 inch

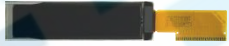
尺寸 Size		2.26 inch		2.26 inch
分辨率 Number of Pixels		16Characters(5x8)x2		16Characters(5x8)x2
驱动 Driver IC		KS0066		SSD1311(US2066)
显示区域 Active Area		56.22x11.52mm		56.22x11.52mm
面板尺寸 Panel Size		66.1x16.7x2mm		68.5x17.5x2mm
颜色 Color		(White/Yellow)		(White/Blue)
接口 Interface		4-SPI,IIC,8-bit 68XX/80XX		4-SPI,IIC,8-bit 68XX/80XX
管脚 Pin		35pins 0.62mm pitch		33pins 0.7mm pitch
系统供电 System Voltage		3.3V		3.3V

尺寸 Size		2.89 inch		2.93 inch
分辨率 Number of Pixels		20Characters(5x8)x4		20Characters(5x8)x2
驱动 Driver IC		SSD1311(US2066)		SSD1311(US2066)
显示区域 Active Area		70.42x20.82mm		73.52x11.52mm
面板尺寸 Panel Size		84.5x27.5x2mm		84.5x19.28x2mm
颜色 Color		(White/Blue)		(White/Green/Blue/Red)
接口 Interface		4-SPI,IIC,8-bit 68XX/80XX		4-SPI,IIC,8-bit 68XX/80XX
管脚 Pin		33pins 0.7mm pitch		33pins 0.7mm pitch
系统供电 System Voltage		3.3V		3.3V

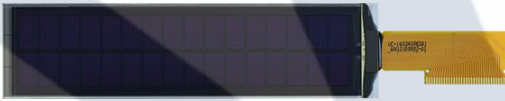
尺寸 Size		3.67 inch		3.67 inch
分辨率 Number of Pixels		16Characters(5x8)x2		16Characters(5x8)x2
驱动 Driver IC		SSD1311(US2066)		SSD1311(US2066)
显示区域 Active Area		91.14x18.98mm		91.14x18.98mm
面板尺寸 Panel Size		105x26.5x2mm		105x26.5x2mm
颜色 Color		(White/Green/Blue/Red/Yellow)		(White/Green/Blue/Red/Yellow)
接口 Interface		4-SPI,IIC,8-bit 68XX/80XX		4-SPI,IIC,8-bit 68XX/80XX
管脚 Pin		33pins 0.7mm pitch		33pins 0.7mm pitch
系统供电 System Voltage		3.3V		3.3V

尺寸 Size		5.80 inch		5.80 inch
分辨率 Number of Pixels		40Characters(5x8)x2		40Characters(5x8)x2
驱动 Driver IC		SH1111(KS0066)		SH1111(KS0066)
显示区域 Active Area		73.52x11.52mm		73.52x11.52mm
面板尺寸 Panel Size		84.5x19.28x2mm		84.5x19.28x2mm
颜色 Color		(White/Blue/Yellow)		(White/Blue/Yellow)
接口 Interface		4-SPI,IIC,8-bit 68XX/80XX		4-SPI,IIC,8-bit 68XX/80XX
管脚 Pin		43pins 0.62mm pitch		43pins 0.62mm pitch
系统供电 System Voltage		3.3V		3.3V

TaiLing Electronic Hardware Manufacturing Co., Ltd.



PRODUCT MANUAL



—专注于 OLED/LCD的生产制造—



-Focusing on the production and manufacturing of OLED/LCD/TFT-



Display Module

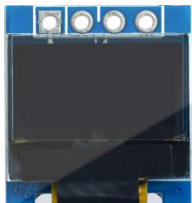

OLED/LCD/Electronic Paper/Character Screen

PRODUCTION **MANUFACTURING**



尺寸 Size		0.42 inch		0.42 inch
分辨率 Number of Pixels		72x40		72x40
驱动 Driver IC		SSD1315		SSD1315
显示区域 Active Area		9.2x5.18mm		9.2x5.18mm
模块尺寸 Module Size		12x 11x2.75mm		12x 11x2.75mm
颜色 Color		Monochrome(White)		Monochrome(White)
接口 Interface		IIC		SPI/IIC
管脚 Pin		4		7
系统供电 System Voltage		3.3V		3.3V



尺寸 Size		0.49 inch		0.66 inch
分辨率 Number of Pixels		64x32		64x48
驱动 Driver IC		SSD1315		SSD1306
显示区域 Active Area		11.18x5.58mm		13.42x10.06mm
模块尺寸 Module Size		15x16x2.4mm		19x23.44x2.45mm
颜色 Color		Monochrome(White)		(White/Blue)
接口 Interface		IIC		IIC
管脚 Pin		4		4
系统供电 System Voltage		3.3V		3.3V



尺寸 Size		0.66 inch		0.66 inch
分辨率 Number of Pixels		64x48		64x48
驱动 Driver IC		SSD1306		SSD1306
显示区域 Active Area		13.42x10.06mm		13.42x10.06mm
模块尺寸 Module Size		29x23.5x2.45mm		19x23.44x2.45mm
颜色 Color		Monochrome(White)		(White/Blue)
接口 Interface		IIC		4-SPI/IIC
管脚 Pin		4		7
系统供电 System Voltage		3.3V		3.3V



尺寸 Size		0.66 inch		0.69 inch
分辨率 Number of Pixels		64x48		96x16
驱动 Driver IC		SSD1306		SSD1306
显示区域 Active Area		13.42x10.06mm		8x17.2mm
模块尺寸 Module Size		29x23.5x2.45mm		10x32.54x2.4mm
颜色 Color		(White/Blue)		(White)
接口 Interface		4-SPI/IIC		IIC
管脚 Pin		7		4
系统供电 System Voltage		3.3V		3.3V

OLED单色模块 Monochrome OLED Module

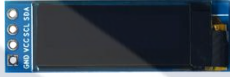

尺寸 Size		0.72 inch		0.77 inch
分辨率 Number of Pixels		128x72		128x64
驱动 Driver IC		SSD1320		SSD1312
显示区域 Active Area		16.01x9.0mm		16.01x9.0mm
面板尺寸 Panel Size		28x32.54x2.4mm		28x32.54x2.4mm
模块尺寸 Module Size		(White)		(White)
接口 Interface		4-SPI		4-SPI
管脚 Pin		4		4
系统供电 System Voltage		3.3V		3.3V

尺寸 Size		0.82 inch		0.86 inch
分辨率 Number of Pixels		96x39		96x32
驱动 Driver IC		SSD1306		SSD1316
显示区域 Active Area		19.18x7.86mm		6.06x21.1mm
面板尺寸 Panel Size		24x26.2x2.5mm		12x38x2.4mm
模块尺寸 Module Size		(White/Blue)		(White)
接口 Interface		IIC		IIC
管脚 Pin		4		4
系统供电 System Voltage		3.3V		3.3V

尺寸 Size		0.91 inch		0.91 inch
分辨率 Number of Pixels		128x32		128x32
驱动 Driver IC		SSD1306		SSD1306
显示区域 Active Area		6.06x22.38mm		6.06x22.38mm
面板尺寸 Panel Size		12x38x2.6mm		32.5x20.5x2.4mm
模块尺寸 Module Size		(White)		(White/Blue/Yellow)
接口 Interface		IIC		SPI
管脚 Pin		4		7
系统供电 System Voltage		3.3V		3.3V



尺寸 Size		0.96 inch GND		0.96 inch VCC
分辨率 Number of Pixels		128x64		128x64
驱动 Driver IC		SSD1306		SSD1306
显示区域 Active Area		21.74x10.86mm		21.74x10.86mm
模块尺寸 Module Size		27.3x27.8x2.65mm		27.3x27.8x2.65mm
颜色 Color		W/B/B+Y		W/B/B+Y
接口 Interface		IIC		IIC
管脚 Pin		4		4
系统供电 System Voltage		3.3V		3.3V

OLED单色模块 Monochrome OLED Module

尺寸 Size		0.96 inch		0.96 inch 带字库
分辨率 Number of Pixels		128x64		128x64
驱动 Driver IC		SSD1306		SSD1306
显示区域 Active Area		21.744x10.864mm		21.74x10.86mm
模块尺寸 Module Size		27.6x27.3x2.65mm		27.3x27.8x2.65mm
颜色 Color		W/B/B+Y		W/B/B+Y
接口 Interface		IIC		SPI
管脚 Pin		4		8
系统供电 System Voltage		3.3V		3.3V

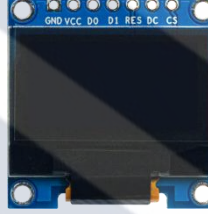
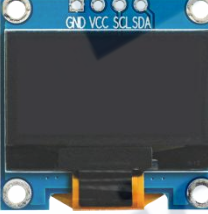
尺寸 Size		0.96 inch		0.96 inch VCC
分辨率 Number of Pixels		128x64		128x64
驱动 Driver IC		SSD1306		SSD1306
显示区域 Active Area		21.74x10.86mm		21.74x10.86mm
模块尺寸 Module Size		27.3x27.8x2.65mm		27.3x27.8x2.65mm
颜色 Color		W/B/B+Y		W/B/B+Y
接口 Interface		SPI/IIC		SPI/IIC
管脚 Pin		6		6
系统供电 System Voltage		3.3V		3.3V



尺寸 Size		0.96 inch		0.96 inch
分辨率 Number of Pixels		128x64		128x64
驱动 Driver IC		SSD1306		SSD1315
显示区域 Active Area		21.74x10.86mm		21.74x10.86mm
模块尺寸 Module Size		27.3x27.8x2.65mm		26x26x2.62mm
颜色 Color		W/B/B+Y		W/B/B+Y
接口 Interface		SPI/IIC		IIC
管脚 Pin		7		4
系统供电 System Voltage		3.3V		3.3V

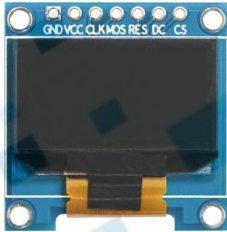

尺寸 Size		0.96 inch VCC		0.96 inch
分辨率 Number of Pixels		128x64		128x64
驱动 Driver IC		SSD1315		SSD1315
显示区域 Active Area		21.74x10.86mm		21.74x10.86mm
模块尺寸 Module Size		26x26x2.62mm		26x26x2.62mm
颜色 Color		W/B/B+Y		W/B/B+Y
接口 Interface		IIC		IIC/SPI
管脚 Pin		4		6
系统供电 System Voltage		3.3V		3.3V

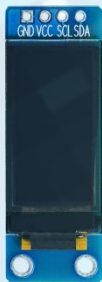
OLED单色模块 Monochrome OLED Module

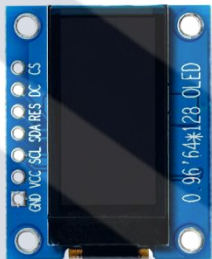

尺寸 Size		0.96 inch 新款		0.96 inch 老款
分辨率 Number of Pixels		128x64		128x64
驱动 Driver IC		SSD1315		SSD1315
显示区域 Active Area		21.74x10.86mm		21.74x10.86mm
模块尺寸 Module Size		26x26x2.62mm		27.3x27.8x2.65mm
颜色 Color		W/B/B+Y		W/B/B+Y
接口 Interface		IIC/SPI		SPI
管脚 Pin		7		7
系统供电 System Voltage		3.3V		3.3V



尺寸 Size		0.96 inch		0.96 inch
分辨率 Number of Pixels		96x96		64x128
驱动 Driver IC		SSD1317		SSD1312
显示区域 Active Area		17.26x17.26mm		21.74x10.86mm
模块尺寸 Module Size		24.20x35.70x2.4mm		40x14.20x2.42mm
颜色 Color		(White)		(White)
接口 Interface		SPI		IIC
管脚 Pin		7		4
系统供电 System Voltage		3.3V		3.3V

尺寸 Size		0.96 inch		1.04 inch
分辨率 Number of Pixels		64x128		128x32
驱动 Driver IC		SH1107		SSD1306
显示区域 Active Area		10.86x21.74mm		25.58x14.5mm
模块尺寸 Module Size		24x30x2.42mm		30.4x24.5x2.5mm
颜色 Color		(White)		(White)
接口 Interface		IIC/SPI		IIC
管脚 Pin		7		4
系统供电 System Voltage		3.3V		3.3V



尺寸 Size		1.04 inch		1.09 inch
分辨率 Number of Pixels		128x32		64x128
驱动 Driver IC		SSD1306		SSD1312
显示区域 Active Area		25.58x14.5mm		25.7x14.20mm
模块尺寸 Module Size		30.4x24.5x2.5mm		45.96x14.2x2.5mm
颜色 Color		(White)		(White)
接口 Interface		IIC/SPI		IIC/SPI
管脚 Pin		7		4
系统供电 System Voltage		3.3V		3.3V

OLED单色模块 Monochrome OLED Module

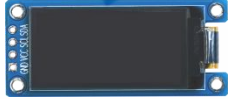

尺寸 Size		1.09 inch		1.09 inch 带字库
分辨率 Number of Pixels		64x128		64x128
驱动 Driver IC		SSD1312		SSD1312
显示区域 Active Area		25.58x10.86mm		25.58x10.86mm
模块尺寸 Module Size		33x24x2.42mm		33x24x2.42mm
颜色 Color		(White)		(White)
接口 Interface		4-SPI		4-SPI
管脚 Pin		7		8
系统供电 System Voltage		3.3V		3.3V



尺寸 Size		1.12 inch		1.12 inch
分辨率 Number of Pixels		96x96		128x128
驱动 Driver IC		SSD1327		SH1107
显示区域 Active Area		20.14x20.14mm		20.08x20.08mm
模块尺寸 Module Size		35x28x2.7mm		26.2x40.10x2.7mm
颜色 Color		(White)灰阶		(White)
接口 Interface		4-SPI		IIC
管脚 Pin		7		5
系统供电 System Voltage		3.3V		3.3V



尺寸 Size		1.12 inch		1.29 inch
分辨率 Number of Pixels		128x128		128x64
驱动 Driver IC		SH1107		CH1115
显示区域 Active Area		20.08x20.08mm		29.42x14.7mm
模块尺寸 Module Size		35x28x2.7mm		45.8x28x2.42mm
颜色 Color		(White)		(White)
接口 Interface		4-SPI/IIC		IIC
管脚 Pin		7		4
系统供电 System Voltage		3.3V		3.3V



尺寸 Size		1.29 inch		1.29 inch
分辨率 Number of Pixels		128x64		128x64
驱动 Driver IC		CH1115		SSD1315
显示区域 Active Area		29.42x14.7mm		28x14.7mm
模块尺寸 Module Size		45.8x28x2.42mm		33x32x2.63mm
颜色 Color		(White)		(White/Blue)
接口 Interface		SPI/IIC		IIC
管脚 Pin		7		4
系统供电 System Voltage		3.3V		3.3V

OLED单色模块 Monochrome OLED Module



尺寸 Size		1.29 inch		1.30 inch
分辨率 Number of Pixels		128x64		64x128
驱动 Driver IC		SSD1315		SSD1312
显示区域 Active Area		28x14.7mm		14.7x29.42mm
模块尺寸 Module Size		33x32x2.63mm		20x45.8x2.78mm
颜色 Color		(White/Blue)		(White)
接口 Interface		SPI/IIC		IIC
管脚 Pin		7		4
系统供电 System Voltage		3.3V		3.3V



尺寸 Size		1.30 inch 带铁框		1.30 inch
分辨率 Number of Pixels		64x128		64x128
驱动 Driver IC		SSD1312		SH1107
显示区域 Active Area		14.7x29.42mm		14.7x29.42mm
模块尺寸 Module Size		20x45.8x2.78mm		27.4x38x2.78mm
颜色 Color		(White)		(White)
接口 Interface		IIC		SPI/IIC
管脚 Pin		4		4
系统供电 System Voltage		3.3V		3.3V

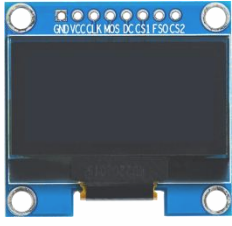

尺寸 Size		1.30 inch		1.30 inch VCC
分辨率 Number of Pixels		128x64		128x64
驱动 Driver IC		SH1106		SH1106
显示区域 Active Area		29.42x14.7mm		29.42x14.7mm
模块尺寸 Module Size		35.4x33.5x2.6mm		35.4x33.5x2.6mm
颜色 Color		(White/Blue)		(White/Blue)
接口 Interface		SPI/IIC		IIC
管脚 Pin		4		4
系统供电 System Voltage		3.3V		3.3V

尺寸 Size		1.30 inch		1.30 inch
分辨率 Number of Pixels		128x64		128x64
驱动 Driver IC		SH1106		SH1106
显示区域 Active Area		29.42x14.7mm		29.42x14.7mm
模块尺寸 Module Size		35.4x33.5x2.6mm		35.4x33.5x2.6mm
颜色 Color		(White/Blue)		(White/Blue)
接口 Interface		SPI/IIC		SPI/IIC
管脚 Pin		6		7
系统供电 System Voltage		3.3V		3.3V

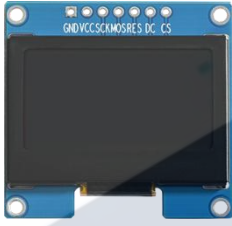
OLED单色模块 Monochrome OLED Module

尺寸 Size		1.30 inch 带字库		1.30 inch 带铁框
分辨率 Number of Pixels		128x64		128x64
驱动 Driver IC		SH1106		SH1106
显示区域 Active Area		29.42x14.7mm		29.42x14.7mm
模块尺寸 Module Size		35.4x33.5x2.6mm		36.7x35x3mm
颜色 Color		(White/Blue)		(White/Blue)
接口 Interface		SPI		SPI/IIC
管脚 Pin		8		4
系统供电 System Voltage		3.3V		3.3V

尺寸 Size		1.30 inch 带铁框		1.32 inch 灰阶
分辨率 Number of Pixels		128x64		128x96
驱动 Driver IC		SH1106		SSD1327
显示区域 Active Area		29.42x14.7mm		26.86x20.14mm
模块尺寸 Module Size		36.7x35x3mm		33x40x2.81mm
颜色 Color		(White/Blue)		(White)
接口 Interface		SPI/IIC		IIC
管脚 Pin		7		5
系统供电 System Voltage		3.3V		3.3V

尺寸 Size		1.32 inch 灰阶		1.50 inch
分辨率 Number of Pixels		128x96		128x128
驱动 Driver IC		SSD1327		SH1107
显示区域 Active Area		26.86x20.14mm		26.86x26.86mm
模块尺寸 Module Size		33x40x2.81mm		34x49.3x2.64mm
颜色 Color		(White)		(White)
接口 Interface		SPI/IIC		IIC
管脚 Pin		7		5
系统供电 System Voltage		3.3V		3.3V

尺寸 Size		1.50 inch		1.50 inch 灰阶
分辨率 Number of Pixels		128x128		128x128
驱动 Driver IC		SH1107		SSD1327
显示区域 Active Area		26.86x26.86mm		26.86x26.86mm
模块尺寸 Module Size		34x49.3x2.64mm		34x47x2.61mm
颜色 Color		(White)		(White/Yellow)
接口 Interface		SPI/IIC		IIC
管脚 Pin		7		5
系统供电 System Voltage		3.3V		3.3V

OLED单色模块 Monochrome OLED Module



尺寸 Size		1.50 inch 灰阶		1.54 inch
分辨率 Number of Pixels		128x128		128x64
驱动 Driver IC		SSD1327		SSD1309/CH1116
显示区域 Active Area		26.86x26.86mm		35.05x17.52mm
模块尺寸 Module Size		34x47x2.61mm		42.40x38x2.75mm
颜色 Color		(White/Yellow)		(White/Blue/Yellow)
接口 Interface		SPI/IIC		IIC
管脚 Pin		7		5
系统供电 System Voltage		3.3V		3.3V



尺寸 Size		1.54 inch		1.54 inch 带铁框
分辨率 Number of Pixels		128x64		128x64
驱动 Driver IC		SSD1309/CH1116		SSD1309/CH1116
显示区域 Active Area		35.05x17.52mm		35.05x17.52mm
模块尺寸 Module Size		42.40x38x2.75mm		44x40x3.9mm
颜色 Color		(White/Blue/Yellow)		(White/Blue/Yellow)
接口 Interface		SPI/IIC		SPI/IIC
管脚 Pin		7		7
系统供电 System Voltage		3.3V		3.3V



尺寸 Size		1.54 inch 5V 带铁框		1.54 inch 带字库
分辨率 Number of Pixels		128x64		128x64
驱动 Driver IC		SSD1309/CH1116		SSD1309/CH1116
显示区域 Active Area		35.05x17.52mm		35.05x17.52mm
模块尺寸 Module Size		44x40x3.9mm		42.40x38x2.75mm
颜色 Color		(White/Blue/Yellow)		(White/Blue/Yellow)
接口 Interface		SPI/IIC		SPI
管脚 Pin		7		9
系统供电 System Voltage		5V		3.3V

尺寸 Size		1.54 inch 带泡棉		1.54 inch
分辨率 Number of Pixels		160x80		160x80
驱动 Driver IC		SSD1320		SSD1320
显示区域 Active Area		35.02x18mm		35.02x18mm
模块尺寸 Module Size		55.5x23x6.6mm		55.5x23x4.6mm
颜色 Color		(White) 灰阶		(White) 灰阶
接口 Interface		IIC		IIC
管脚 Pin		5		5
系统供电 System Voltage		3.3V		3.3V

OLED单色模块 Monochrome OLED Module



尺寸 Size		1.54 inch 带泡棉		1.54 inch
分辨率 Number of Pixels		160x80		160x80
驱动 Driver IC		SSD1320		SSD1320
显示区域 Active Area		35.02x18mm		35.02x18mm
模块尺寸 Module Size		55.5x23x6.6mm		55.5x23x4.6mm
颜色 Color		(White) 灰阶		(White) 灰阶
接口 Interface		SPI/IIC		SPI/IIC
管脚 Pin		7		7
系统供电 System Voltage		3.3V		3.3V

尺寸 Size		1.71 inch		1.71 inch
分辨率 Number of Pixels		128x32		128x32
驱动 Driver IC		SSD1312		SSD1312
显示区域 Active Area		42.22x10.54mm		42.22x10.54mm
模块尺寸 Module Size		60.5x18.75x3.6mm		60.5x18.75x3.6mm
颜色 Color		(White)		(White)
接口 Interface		IIC		SPI/IIC
管脚 Pin		4		7
系统供电 System Voltage		3.3V		3.3V

尺寸 Size		1.92 inch		1.92 inch
分辨率 Number of Pixels		128x160		128x160
驱动 Driver IC		SH1108		SH1108
显示区域 Active Area		28.91x39.34mm		28.91x39.34mm
模块尺寸 Module Size		60x37x3.03mm		60x37x3.03mm
颜色 Color		(White)		(White)
接口 Interface		IIC		SPI/IIC
管脚 Pin		4		7
系统供电 System Voltage		3.3V		3.3V

尺寸 Size		2.08 inch		2.08 inch
分辨率 Number of Pixels		128x32		128x32
驱动 Driver IC		SSD1307		SSD1307
显示区域 Active Area		51.18x12.78mm		51.18x12.78mm
模块尺寸 Module Size		72.5x27.24x2.83mm		72.5x27.24x2.83mm
颜色 Color		(White)		(White)
接口 Interface		IIC		SPI/IIC
管脚 Pin		4		7
系统供电 System Voltage		3.3V		3.3V

OLED单色模块 Monochrome OLED Module

尺寸 Size		2.08 inch 灰阶		2.08 inch 灰阶
分辨率 Number of Pixels		256x64		256x64
驱动 Driver IC		SH1122		SH1122
显示区域 Active Area		51.18x12.78mm		51.18x12.78mm
模块尺寸 Module Size		72.5x27.24x2.8mm		72.5x27.24x2.8mm
颜色 Color		(White/Blue)		(White/Blue)
接口 Interface		IIC		SPI/IIC
管脚 Pin		4		7
系统供电 System Voltage		3.3V		3.3V

尺寸 Size		2.08 inch 带字库		2.23 inch
分辨率 Number of Pixels		256x64		128x32
驱动 Driver IC		SH1122		SSD1305
显示区域 Active Area		51.18x12.78mm		55.02x13.10mm
模块尺寸 Module Size		72.5x27.24x2.8mm		74x30x5.5mm
颜色 Color		(White/Blue) 灰阶		White, Blue, Yellow, Green
接口 Interface		SPI		IIC
管脚 Pin		10		5
系统供电 System Voltage		3.3V		3.3V

尺寸 Size		2.23 inch		2.23 inch
分辨率 Number of Pixels		128x32		128x32
驱动 Driver IC		SSD1305		SSD1305
显示区域 Active Area		55.02x13.10mm		55.02x13.10mm
模块尺寸 Module Size		74x30x5.5mm		74x30x5.5mm
颜色 Color		Orange		White, Blue, Yellow, Green
接口 Interface		IIC		SPI/IIC
管脚 Pin		5		7
系统供电 System Voltage		3.3V		3.3V

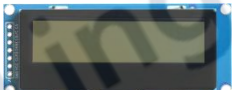
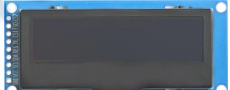
尺寸 Size		2.23 inch		2.23 inch 带字库
分辨率 Number of Pixels		128x32		128x32
驱动 Driver IC		SSD1305		SSD1305
显示区域 Active Area		55.02x13.10mm		55.02x13.10mm
模块尺寸 Module Size		74x30x5.5mm		74x27.24x5.5mm
颜色 Color		Orange		White, Blue, Yellow, Green
接口 Interface		SPI/IIC		SPI
管脚 Pin		7		9
系统供电 System Voltage		3.3V		3.3V

OLED单色模块 Monochrome OLED Module

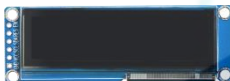
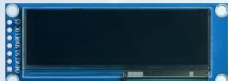

尺寸 Size		2.23 inch 带字库		2.23 inch
分辨率 Number of Pixels		128x32		128x33
驱动 Driver IC		SSD1305		SSD1305
显示区域 Active Area		55.02x13.10mm		55.02x13.18mm
模块尺寸 Module Size		74x27.24x5.5mm		74.3x25x3.2mm
颜色 Color		Orange		Blue
接口 Interface		SPI		IIC
管脚 Pin		9		4
系统供电 System Voltage		3.3V		3.3V

尺寸 Size		2.23 inch		2.23 inch
分辨率 Number of Pixels		128x33		128x33
驱动 Driver IC		SSD1305		SSD1305
显示区域 Active Area		55.02x13.18mm		55.02x13.18mm
模块尺寸 Module Size		74.3x24.5x3.2mm		74.3x27.8x3.2mm
颜色 Color		Blue		Blue
接口 Interface		IIC		SPI/IIC
管脚 Pin		6		7
系统供电 System Voltage		3.3V		3.3V

尺寸 Size		2.23 inch		2.23 inch 带字库
分辨率 Number of Pixels		128x33		128x33
驱动 Driver IC		SSD1305		SSD1305
显示区域 Active Area		55.02x13.18mm		55.02x13.18mm
模块尺寸 Module Size		72.3x24.5x3.2mm		72.3x24.5x3.2mm
颜色 Color		Blue		Blue
接口 Interface		4-SPI		SPI
管脚 Pin		8		10
系统供电 System Voltage		3.3V		3.3V

尺寸 Size		2.42 inch 铁框		2.42 inch 铁框
分辨率 Number of Pixels		128x64		128x64
驱动 Driver IC		SSD1305		SSD1309
显示区域 Active Area		55.01x27.49mm		55.01x27.49mm
模块尺寸 Module Size		72x43x4.2mm		72x43x4.2mm
颜色 Color		White		White, Blue, Yellow, Green
接口 Interface		4-SPI/IIC		4-SPI/IIC
管脚 Pin		7		7 插接
系统供电 System Voltage		3.3V		3.3V

OLED单色模块 Monochrome OLED Module



尺寸 Size		2.42 inch 铁框		2.42 inch 铁框
分辨率 Number of Pixels		128x64		128x64
驱动 Driver IC		SSD1309		SSD1309
显示区域 Active Area		55.01x27.49mm		55.01x27.49mm
模块尺寸 Module Size		72x43x4.2mm		72x43x4.2mm
颜色 Color		White, Blue, Yellow, Green		White, Blue, Yellow, Green
接口 Interface		4-SPI/IIC		IIC
管脚 Pin		7		5
系统供电 System Voltage		5V		3.3V

尺寸 Size		2.42 inch 铁框		2.42 inch 铁框 字库
分辨率 Number of Pixels		128x64		128x64
驱动 Driver IC		SSD1309		SSD1309
显示区域 Active Area		55.01x27.49mm		55.01x27.49mm
模块尺寸 Module Size		72x43x4.2mm		72x43x4.2mm
颜色 Color		White, Blue, Yellow, Green		White, Blue, Yellow, Green
接口 Interface		4-SPI/IIC		SPI
管脚 Pin		7 焊接		9
系统供电 System Voltage		3.3V		3.3V

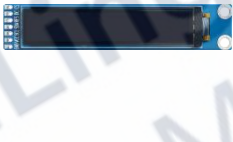
尺寸 Size		2.42 inch 铁框		2.45 inch 灰阶
分辨率 Number of Pixels		128x64		304x96
驱动 Driver IC		SSD1309		SH1126
显示区域 Active Area		55.01x27.49mm		59.26x19.18mm
模块尺寸 Module Size		72x43x4.2mm		88x29.2x3.23mm
颜色 Color		White, Blue, Yellow, Green		Blue
接口 Interface		SPI/IIC/并口		4-SPI/IIC
管脚 Pin		16		7
系统供电 System Voltage		3.3V		3.3V

尺寸 Size		2.55 inch 灰阶		2.7 inch 铁框 灰阶
分辨率 Number of Pixels		206x36		128x64
驱动 Driver IC		SSD1362		SSD1322
显示区域 Active Area		63.84x11.14mm		61.41x30.69mm
模块尺寸 Module Size		90x18x2.8mm		85x50x4.7mm
颜色 Color		White		White/Yellow/Green
接口 Interface		SPI/IIC		SPI
管脚 Pin		7		7
系统供电 System Voltage		3.3V		3.3V

OLED单色模块 Monochrome OLED Module

尺寸 Size		2.7 inch 铁框 灰阶		2.7 inch 铁框 灰阶
分辨率 Number of Pixels		128x64		128x64 带字库
驱动 Driver IC		SSD1325		SSD1325
显示区域 Active Area		61.41x30.69mm		61.41x30.69mm
模块尺寸 Module Size		85x50x4.7mm		85x50x4.7mm
颜色 Color		White/Yellow/Green		White/Yellow/Green
接口 Interface		SPI		SPI
管脚 Pin		7		9
系统供电 System Voltage		3.3V		3.3V

尺寸 Size		2.7 inch 灰阶		2.7 inch 铁框 灰阶
分辨率 Number of Pixels		256x64		256x128
驱动 Driver IC		SSD1322		SSD1363
显示区域 Active Area		66.53x16.61mm		61.42x30.7mm
模块尺寸 Module Size		82x27.5x3.6mm		85x50x4.7mm
颜色 Color		White		White/Yellow/Green
接口 Interface		SPI		SPI/IIC
管脚 Pin		7		4
系统供电 System Voltage		3.3V		3.3V

尺寸 Size		2.7 inch 铁框 灰阶		2.8 inch 铁框 灰阶
分辨率 Number of Pixels		256x128		256x64
驱动 Driver IC		SSD1363		SSD1322
显示区域 Active Area		61.42x30.7mm		69.10x17.26mm
模块尺寸 Module Size		85x50x4.7mm		100x35x4.8mm
颜色 Color		White/Yellow/Green		White/Yellow/Blue
接口 Interface		SPI/IIC		SPI
管脚 Pin		7		7
系统供电 System Voltage		3.3V		3.3V

尺寸 Size		2.8 inch 铁框 灰阶		2.8 inch 铁框 灰阶
分辨率 Number of Pixels		256x64 带字库		256x64
驱动 Driver IC		SSD1322		SSD1322
显示区域 Active Area		69.10x17.26mm		69.10x17.26mm
模块尺寸 Module Size		100x35x4.8mm		100x35x4.8mm
颜色 Color		White/Yellow/Blue		White/Yellow/Blue
接口 Interface		SPI		SPI/并口
管脚 Pin		9		16
系统供电 System Voltage		3.3V		3.3V

OLED单色模块 Monochrome OLED Module

尺寸 Size		3.12 inch 铁框 灰阶		3.12 inch 铁框 灰阶
分辨率 Number of Pixels		256x64		256x64
驱动 Driver IC		SSD1322		SSD1322
显示区域 Active Area		76.78x19.18mm		76.78x19.18mm
模块尺寸 Module Size		102x35x4mm		102x35x4mm
颜色 Color		W/Y/B/G		W/Y/B/G
接口 Interface		SPI		SPI
管脚 Pin		7		7
系统供电 System Voltage		3.3V		5V

尺寸 Size		3.12 inch 铁框 灰阶		3.12 inch 铁框 灰阶
分辨率 Number of Pixels		256x64 带字库		256x64
驱动 Driver IC		SSD1322		SSD1322
显示区域 Active Area		76.78x19.18mm		76.78x19.18mm
模块尺寸 Module Size		102x35x4mm		100.3x38.1x4.9mm
颜色 Color		W/Y/B/G		W/Y/B/G
接口 Interface		SPI		SPI
管脚 Pin		9		10
系统供电 System Voltage		3.3V		3.3V

尺寸 Size		3.12 inch 铁框 灰阶		3.12 inch 灰阶
分辨率 Number of Pixels		256x64		256x64
驱动 Driver IC		SSD1322		SSD1362
显示区域 Active Area		76.78x19.18mm		76.78x19.18mm
模块尺寸 Module Size		102x35x4mm		100x30x5.75mm
颜色 Color		W/Y/B/G		White
接口 Interface		SPI/并口		IIC
管脚 Pin		16		5
系统供电 System Voltage		3.3V		3.3V



尺寸 Size		3.12 inch 灰阶		3.12 inch 灰阶
分辨率 Number of Pixels		256x64		256x64
驱动 Driver IC		SSD1362		SSD1362
显示区域 Active Area		76.78x19.18mm		76.78x19.18mm
模块尺寸 Module Size		100x30x5.75mm		100x30x5.75mm
颜色 Color		White		White
接口 Interface		SPI		SPI/IIC/并口
管脚 Pin		7		16
系统供电 System Voltage		3.3V		3.3V



OLED单色模块 Monochrome OLED Module

尺寸 Size		3.83 inch 灰阶		5.50 inch 铁框 灰阶
分辨率 Number of Pixels		132x320		256x64
驱动 Driver IC		SSD1320		SSD1322
显示区域 Active Area		89.90x37.07mm		135.65x33.89mm
模块尺寸 Module Size		124x42x3.23mm		160x50x4.2mm
颜色 Color		White		W/Y/B/G
接口 Interface		SPI		SPI
管脚 Pin		10		7
系统供电 System Voltage		3.3V		3.3V

尺寸 Size		5.50 inch 铁框 灰阶		5.50 inch 铁框 字库
分辨率 Number of Pixels		256x64		256x64
驱动 Driver IC		SSD1322		SSD1322
显示区域 Active Area		135.65x33.89mm		135.65x33.89mm
模块尺寸 Module Size		160x50x4.2mm		160x50x4.2mm
颜色 Color		W/Y/B/G		W/Y/B/G 灰阶
接口 Interface		SPI/并口		SPI
管脚 Pin		16		9
系统供电 System Voltage		3.3V		3.3V

OLED彩色模块 Full Color OLED Module

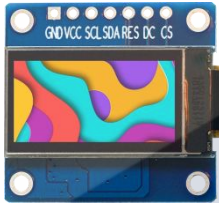
尺寸 Size		0.95 inch 智晶		0.95 inch 维信诺
分辨率 Number of Pixels		96*64		96*64
驱动 Driver IC		SSD1331Z		SSD1331Z
显示区域 Active Area		20.14x13.42mm		20.14x13.42mm
模块尺寸 Module Size		27.3x30.7x2.4mm		27.3x30.7x2.4mm
颜色 Color		65,536 Colors (Max)		65,536 Colors (Max)
接口 Interface		SPI		SPI
管脚 Pin		7		7
系统供电 System Voltage		3.3V		3.3V

尺寸 Size		0.96 inch		1.27 inch
分辨率 Number of Pixels		64*128		96*128
驱动 Driver IC		SSD1357Z		SSD1351
显示区域 Active Area		10.8624x21.736mm		25.708x19.28mm
模块尺寸 Module Size		29x27x1.02mm		33.8x40x1.2mm
颜色 Color		Full Color		Full Color
接口 Interface		4-SPI		4-SPI
管脚 Pin		7		7
供电方式 Driving Power		3.3V		3.3V

尺寸 Size		1.45 inch		1.50 inch 老款
分辨率 Number of Pixels		160*128		128*128
驱动 Driver IC		SEP525		SSD1351
显示区域 Active Area		28.78x23.02mm		26.86x26.86mm
模块尺寸 Module Size		43x42.8x2.6mm		33.8x40x3.0mm
颜色 Color		262,144 Color		262,144 Color
接口 Interface		4-SPI		SPI
管脚 Pin		7		7
供电方式 Driving Power		3.3V		3.3V

尺寸 Size		1.50 inch 新款		1.69 inch 老款
分辨率 Number of Pixels		128*128		160*128
驱动 Driver IC		SSD1351		SEP525
显示区域 Active Area		26.86x26.86mm		33.58x26.86mm
模块尺寸 Module Size		44x36x2.8mm		43x46x2.95mm
颜色 Color		262,144 Color		262,144 Color
接口 Interface		SPI		SPI
管脚 Pin		7		7
供电方式 Driving Power		3.3V		3.3V

OLED彩色模块 Full Color OLED Module

尺寸 Size		1.69 inch 新款		
分辨率 Number of Pixels		160*128		
驱动 Driver IC		SSD1333		
显示区域 Active Area		33.58x26.86mm		
模块尺寸 Module Size		43x46x2.95mm		
颜色 Color		262,144 Color		
接口 Interface		SPI/IIC		
管脚 Pin		7		
供电方式 Driving Power		3.3V		



单色字符模块 Monochrome Character OLED Module



尺寸 Size		2.26 inch 铁框		2.26 inch
分辨率 Number of Pixels		16(5x8)*2		16(5x8)*2
驱动 Driver IC		SSD1311(US2066)		KS0066
显示区域 Active Area		56.22x11.52mm		56.22x11.52mm
模块尺寸 Module Size		80x36x9.7mm		80x20.2x3.0mm
颜色 Color		W/B/Y/G/R		White/Yellow
接口 Interface		SPI/IIC/并口		IIC
管脚 Pin		8		4
系统供电 System Voltage		3.3V		3.3V



尺寸 Size		2.26 inch		2.89 inch 铁框
分辨率 Number of Pixels		16(5x8)*2		20(5x8)*4
驱动 Driver IC		KS0066		SSD1311(US2066)
显示区域 Active Area		56.22x11.52mm		56.22x11.52mm
模块尺寸 Module Size		80x20.2x3.0mm		98x60x13.6mm
颜色 Color		White/Yellow		W/B/R
接口 Interface		SPI/IIC		并口
管脚 Pin		7		16
系统供电 System Voltage		3.3V		3.3V

尺寸 Size		2.93 inch 铁框		
分辨率 Number of Pixels		20(5x8)*2		
驱动 Driver IC		SSD1311(US2066)		
显示区域 Active Area		73.52x11.52mm		
模块尺寸 Module Size		116x37x9.5mm		
颜色 Color		W/B/Y/G/R		
接口 Interface		SPI/IIC/并口		
管脚 Pin		16		
系统供电 System Voltage		3.3V		

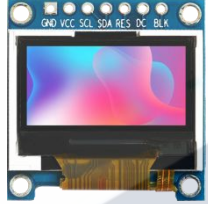
TFT彩色模块 Full Color TFT Module

尺寸 Size		0.85 inch IPS		0.96 inch IPS
分辨率 Number of Pixels		128*128		80*160
驱动 Driver IC		GC9107		ST7735S
显示区域 Active Area		15.21x15.21mm		21.7x10.8mm
模块尺寸 Module Size		22x29.58x2.66mm		30x24x2.7mm
颜色 Color		RGB		RGB
接口 Interface-4-		SPI		4-SPI
管脚 Pin		8		8
系统供电 System Voltage		3.3V		3.3V

尺寸 Size		0.96 inch		1.05 inch IPS
分辨率 Number of Pixels		128*64		120*240
驱动 Driver IC		ST7735S		GC9A01
显示区域 Active Area		21.74x10.86mm		23.76x11.88mm
模块尺寸 Module Size		27.3x27.8x2.8mm		30x24.25x2.8mm
颜色 Color		RGB		262K
接口 Interface		4-SPI		4-SPI
管脚 Pin		8		8
系统供电 System Voltage		3.3V		3.3V



尺寸 Size		1.14 inch IPS		1.14 inch IPS
分辨率 Number of Pixels		135*240		135*240
驱动 Driver IC		ST7789V		ST7789V
显示区域 Active Area		24.91x14.86mm		24.91x14.86mm
模块尺寸 Module Size		31.4x28x2.8mm		31.4x28x2.8mm
颜色 Color		262K		RGB
接口 Interface		4-SPI		8 位并口
管脚 Pin		8		16
系统供电 System Voltage		3.3V		3.3V

尺寸 Size		1.28 inch IPS 电容		1.28 inch IPS 电容
分辨率 Number of Pixels		240*240		240*240
驱动 Driver IC		GC9A01		GC9A01
显示区域 Active Area		32.40x32.40mm		32.40x32.40mm
模块尺寸 Module Size		39x40x4.98mm		36x40x4.7mm
颜色 Color		262K		RGB
接口 Interface		8 位并口		4-SPI
管脚 Pin		-----		8
系统供电 System Voltage		3.3V		3.3V

TFT彩色模块 Full Color TFT Module

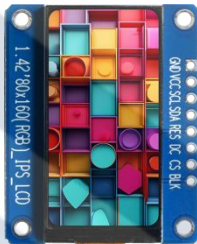

尺寸 Size		1.30 inch IPS 新款		1.30 inch IPS 旧款
分辨率 Number of Pixels		240*240		240*240
驱动 Driver IC		ST7789		ST7789
显示区域 Active Area		23.40x23.40mm		23.40x23.40mm
模块尺寸 Module Size		30.5x38x2.7mm		27.78x39.22x2.7mm
颜色 Color		RGB		RGB
接口 Interface		4-SPI		4-SPI
管脚 Pin		8		7
系统供电 System Voltage		3.3V		3.3V



尺寸 Size		1.30 inch IPS 带字库		1.30 inch IPS
分辨率 Number of Pixels		240*240		240*240
驱动 Driver IC		ST7789		ST7789
显示区域 Active Area		23.40x23.40mm		23.40x23.40mm
模块尺寸 Module Size		27.78x39.22x2.7mm		27.78x39.22x2.7mm
颜色 Color		RGB		RGB
接口 Interface		4-SPI		4-SPI/并口
管脚 Pin		10		18
系统供电 System Voltage		3.3V		3.3V

尺寸 Size		1.42 inch IPS		1.44 inch TFT
分辨率 Number of Pixels		80*160		128*128
驱动 Driver IC		NV3022B3		ST7735
显示区域 Active Area		32.35x16.18mm		25.5x26.5mm
模块尺寸 Module Size		37.38x30x3.43mm		30x44.64x3.46mm
颜色 Color		262K		262K
接口 Interface		4-SPI		4-SPI
管脚 Pin		8		8
系统供电 System Voltage		3.3V		3.3V

尺寸 Size		1.44 inch TFT		1.44 inch TFT 5V
分辨率 Number of Pixels		128*128		128*128
驱动 Driver IC		ST7735		ST7735
显示区域 Active Area		25.5x26.5mm		25.5x26.5mm
模块尺寸 Module Size		30x46.5x3.46mm		30x46.5x3.46mm
颜色 Color		262K		262K
接口 Interface		4-SPI		4-SPI
管脚 Pin		8		8
系统供电 System Voltage		3.3V		5V

TFT彩色模块 Full Color TFT Module

尺寸 Size		1.45 inch TFT		1.47 inch IPS 带字库
分辨率 Number of Pixels		60*160		172*320
驱动 Driver IC		GC9107		ST7789V3
显示区域 Active Area		34.94x13.1mm		32.35x17.39mm
模块尺寸 Module Size		41.5x27x3.4mm		37x30x2.66mm
颜色 Color		RGB		RGB
接口 Interface		4-SPI		4-SPI
管脚 Pin		8		10
系统供电 System Voltage		3.3V		3.3V

尺寸 Size		1.47 inch IPS		1.50 inch IPS
分辨率 Number of Pixels		172*320		240*280
驱动 Driver IC		ST7789V3		NV3030B
显示区域 Active Area		32.35x17.39mm		24.77x28.9mm
模块尺寸 Module Size		37x30x2.66mm		28x45x2.76mm
颜色 Color		RGB		262K
接口 Interface		4-SPI		4-SPI
管脚 Pin		8		8
系统供电 System Voltage		3.3V		3.3V

尺寸 Size		1.50 inch IPS		1.54 inch IPS
分辨率 Number of Pixels		240*280		240*240
驱动 Driver IC		ST7789P3		ST7789
显示区域 Active Area		24.77x28.9mm		27.72x27.72mm
模块尺寸 Module Size		28x45x2.76mm		32x43.72x3.2mm
颜色 Color		262K		262K
接口 Interface		4-SPI		4-SPI
管脚 Pin		8		8
系统供电 System Voltage		3.3V		3.3V



尺寸 Size		1.54 inch IPS 带字库		1.69 inch IPS
分辨率 Number of Pixels		240*240		240*280
驱动 Driver IC		ST7789		ST7789V2
显示区域 Active Area		27.72x27.72mm		27.97x32.63mm
模块尺寸 Module Size		32x43.72x3.2mm		31x48x2.76mm
颜色 Color		262K		262K
接口 Interface		4-SPI		4-SPI
管脚 Pin		10		8
系统供电 System Voltage		3.3V		3.3V

TFT彩色模块 Full Color TFT Module

尺寸 Size		1.69 inch IPS 带字库		1.69 inch TFT
分辨率 Number of Pixels		240*280		240*280
驱动 Driver IC		ST7789V2		ST7789V2
显示区域 Active Area		27.97x32.63mm		27.97x32.63mm
模块尺寸 Module Size		39x42x2.8mm		31x48x2.76mm
颜色 Color		262K		262K
接口 Interface		4-SPI		8Bit 8080 MCU
管脚 Pin		10		16
系统供电 System Voltage		3.3V		3.3V

尺寸 Size		1.77 inch TFT		1.8 inch TFT
分辨率 Number of Pixels		128*160		128*160
驱动 Driver IC		ST7735S		ST7735S
显示区域 Active Area		28.03x35.04mm		28.03x35.04mm
模块尺寸 Module Size		34.6x54.75x3.48mm		35x56x3.56mm
颜色 Color		262K		262K
接口 Interface		4-SPI		4-SPI
管脚 Pin		8		8
系统供电 System Voltage		3.3V		3.3V

尺寸 Size		1.8 inch TFT		1.83 inch IPS
分辨率 Number of Pixels		128*160		240*280
驱动 Driver IC		ST7735S		NV3030B
显示区域 Active Area		28.03x35.04mm		30.2x35.23mm
模块尺寸 Module Size		35x56x3.93mm		32.2x49.23x6.01mm
颜色 Color		262K		262K
接口 Interface		4-SPI		4-SPI
管脚 Pin		8		8
系统供电 System Voltage		3.3V		3.3V

尺寸 Size		1.90 inch IPS		1.90 inch IPS
分辨率 Number of Pixels		170*320		170*320
驱动 Driver IC		ST7789V3		GC9307
显示区域 Active Area		42.72x22.7mm		42.72x22.7mm
模块尺寸 Module Size		32.2x49.23x2.7mm		32.2x49.23x2.7mm
颜色 Color		262K		262K
接口 Interface		4-SPI		4-SPI/8-Bit 8080 MCU
管脚 Pin		8		8
系统供电 System Voltage		3.3V		3.3V

TFT彩色模块 Full Color TFT Module

尺寸 Size		2.0 inch IPS		2.0 inch IPS 带字库
分辨率 Number of Pixels		240*320		240*320
驱动 Driver IC		ST7789V2		ST7789V2
显示区域 Active Area		30.6x40.08mm		30.6x40.08mm
模块尺寸 Module Size		36x63.2x3.4mm		36x63.2x3.4mm
颜色 Color		65K		65K
接口 Interface		4-SPI		4-SPI
管脚 Pin		8		10
系统供电 System Voltage		3.3V		3.3V

尺寸 Size		2.08 inch TFT		2.25 inch TFT
分辨率 Number of Pixels		128*160		76*284
驱动 Driver IC		NV3023B		ST7789
显示区域 Active Area		31.87x39.84mm		55.29x14.8mm
模块尺寸 Module Size		37.7x60x3.62mm		63x30x3.76mm
颜色 Color		262K		RGB
接口 Interface		4-SPI		4-SPI
管脚 Pin		8		8
系统供电 System Voltage		3.3V		3.3V

尺寸 Size		2.4 inch TFT 新款		2.4 inch TFT 旧款
分辨率 Number of Pixels		240*320		240*320
驱动 Driver IC		ILI9341/ST7789		ILI9341/ST7789
显示区域 Active Area		36.72x48.96mm		36.72x48.96mm
模块尺寸 Module Size		43x72.26x3.75mm		43x72.26x3.75mm
颜色 Color		RGB		RGB
接口 Interface		4-SPI		4-SPI
管脚 Pin		8		8
系统供电 System Voltage		3.3V		3.3V

尺寸 Size		2.4 inch TFT 带字库		2.4 inch TFT
分辨率 Number of Pixels		240*320		240*320
驱动 Driver IC		ILI9341/ST7789		ILI9341/ST7789
显示区域 Active Area		36.72x48.96mm		36.72x48.96mm
模块尺寸 Module Size		43x72.26x3.75mm		43x72.26x3.75mm
颜色 Color		RGB		RGB
接口 Interface		4-SPI		8-Bit 8080 MCU
管脚 Pin		10		16
系统供电 System Voltage		3.3V		3.3V

TFT彩色模块 Full Color TFT Module

尺寸 Size		2.4 inch TFT		2.4 inch TFT 电阻触摸
分辨率 Number of Pixels		240*320		240*320
驱动 Driver IC		ILI9341/ST7789		ILI9341/ST7789
显示区域 Active Area		36.72x48.96mm		36.72x48.96mm
模块尺寸 Module Size		43x72.26x3.75mm		43x72.26x4.95mm
颜色 Color		RGB		RGB
接口 Interface		16-Bit 8080 MCU		4-SPI
管脚 Pin		24		10
系统供电 System Voltage		3.3V		3.3V

尺寸 Size		2.4 inch IPS		2.8 inch TFT 新款
分辨率 Number of Pixels		240*320		240*320
驱动 Driver IC		ST7789		ILI9341/ST7789
显示区域 Active Area		36.72x48.96mm		43.2x57.6mm
模块尺寸 Module Size		41x69x2.20mm		51x81.2x3.8mm
颜色 Color		RGB		RGB
接口 Interface		4-SPI		4-SPI
管脚 Pin		8		8
系统供电 System Voltage		3.3V		3.3V

尺寸 Size		2.8 inch TFT 旧款		2.8 inch TFT 带字库
分辨率 Number of Pixels		240*320		240*320
驱动 Driver IC		ILI9341/ST7789		ILI9341/ST7789
显示区域 Active Area		43.2x57.6mm		43.2x57.6mm
模块尺寸 Module Size		51x81.2x3.8mm		51x81.2x3.8mm
颜色 Color		RGB		RGB
接口 Interface		4-SPI		4-SPI
管脚 Pin		8		10
系统供电 System Voltage		3.3V		3.3V

尺寸 Size		2.8 inch TFT 带字库		2.8 inch TFT
分辨率 Number of Pixels		240*320		240*320
驱动 Driver IC		ILI9341/ST7789		ILI9341/ST7789
显示区域 Active Area		43.2x57.6mm		43.2x57.6mm
模块尺寸 Module Size		51x81.2x3.8mm		51x81.2x3.8mm
颜色 Color		RGB		RGB
接口 Interface		4-SPI		8-Bit 8080 MCU
管脚 Pin		11		16
系统供电 System Voltage		3.3V		3.3V

TFT彩色模块 Full Color TFT Module

尺寸 Size		2.8 inch TFT		2.8 inch IPS 铁框
分辨率 Number of Pixels		240*320		240*320
驱动 Driver IC		ILI9341/ST7789		ST7789
显示区域 Active Area		43.2x57.6mm		43.2x57.6mm
模块尺寸 Module Size		51x81.2x3.8mm		48x79x3.33mm
颜色 Color		RGB		RGB
接口 Interface		16-Bit 8080 MCU		4-SPI
管脚 Pin		24		8
系统供电 System Voltage		3.3V		3.3V

尺寸 Size		2.8 inch IPS 电容触摸		3.2 inch TFT 老款
分辨率 Number of Pixels		240*320		240*320
驱动 Driver IC		ST7789		ILI9341/ST7789
显示区域 Active Area		43.2x57.6mm		48.6x64.8mm
模块尺寸 Module Size		55.3x78.95x4.76mm		54x89.4x3.6mm
颜色 Color		RGB565		RGB
接口 Interface		4-SPI		4-SPI
管脚 Pin		11		8
系统供电 System Voltage		3.3V		3.3V

尺寸 Size		3.2 inch TFT 新款		3.2 inch TFT 带字库
分辨率 Number of Pixels		240*320		240*320
驱动 Driver IC		ILI9341/ST7789		ILI9341/ST7789
显示区域 Active Area		48.6x64.8mm		48.6x64.8mm
模块尺寸 Module Size		56x89.4x3.6mm		56x89.4x3.6mm
颜色 Color		RGB		RGB
接口 Interface		4-SPI		4-SPI
管脚 Pin		8		10
系统供电 System Voltage		3.3V		3.3V

尺寸 Size		3.2 inch TFT 电阻		3.2 inch TFT
分辨率 Number of Pixels		240*320		240*320
驱动 Driver IC		ILI9341/ST7789		ILI9341/ST7789
显示区域 Active Area		48.6x64.8mm		48.6x64.8mm
模块尺寸 Module Size		56x89.4x3.75mm		56x89.4x3.75mm
颜色 Color		RGB		RGB
接口 Interface		4-SPI		8-Bit 8080 MCU
管脚 Pin		11		16
系统供电 System Voltage		3.3V		3.3V

TFT彩色模块 Full Color TFT Module

尺寸 Size		3.2 inch TFT		3.2 inch TFT 电阻
分辨率 Number of Pixels		240*320		240*320
驱动 Driver IC		ILI9341/ST7789		ILI9341/ST7789
显示区域 Active Area		48.6x64.8mm		48.6x64.8mm
模块尺寸 Module Size		56x89.4x3.75mm		56x89.4x4.95mm
颜色 Color		RGB		RGB
接口 Interface		16-Bit 8080 MCU		16-Bit 8080 MCU
管脚 Pin		24		34
系统供电 System Voltage		3.3V		3.3V

尺寸 Size		3.5 inch TFT 老款		3.5 inch TFT 新款
分辨率 Number of Pixels		320*480		320*480
驱动 Driver IC		ILI9488/ST7796		ILI9488/ST7796
显示区域 Active Area		48.96x73.44mm		48.96x73.44mm
模块尺寸 Module Size		57.26x96.52x3.9mm		57.26x96.52x3.9mm
颜色 Color		RGB		RGB
接口 Interface		SPI		SPI
管脚 Pin		8		8
系统供电 System Voltage		3.3V		3.3V

尺寸 Size		3.5 inch TFT 带字库		3.5 inch TFT 电阻触摸
分辨率 Number of Pixels		320*480		320*480
驱动 Driver IC		ILI9488/ST7796		ILI9488/ST7796
显示区域 Active Area		48.96x73.44mm		48.96x73.44mm
模块尺寸 Module Size		57.26x96.52x3.9mm		57.26x96.52x5.2mm
颜色 Color		RGB		RGB
接口 Interface		4-SPI		4-SPI
管脚 Pin		10		11
系统供电 System Voltage		3.3V		3.3V

尺寸 Size		3.5 inch TFT		3.5 inch TFT 电阻触摸
分辨率 Number of Pixels		320*480		320*480
驱动 Driver IC		ILI9488/ST7796		ILI9488/ST7796
显示区域 Active Area		48.96x73.44mm		48.96x73.44mm
模块尺寸 Module Size		57.26x96.52x3.9mm		57.26x96.52x5.2mm
颜色 Color		RGB		RGB
接口 Interface		16-Bit 8080 MCU		16-Bit 8080 MCU
管脚 Pin		24		34
系统供电 System Voltage		3.3V		3.3V

TFT彩色模块 Full Color TFT Module

尺寸 Size		3.5 inch TFT 电容		3.5 inch TFT 电容
分辨率 Number of Pixels		320*480		320*480
驱动 Driver IC		ST7796		ST7796
显示区域 Active Area		48.96x73.44mm		48.96x73.44mm
模块尺寸 Module Size		57.26x96.52x5.48mm		57.26x96.52x5.48mm
颜色 Color		RGB		RGB
接口 Interface		4-SPI		8-Bit 8080 MCU
管脚 Pin		11		20
系统供电 System Voltage		3.3V		3.3V

尺寸 Size		3.5 inch TFT 电容		3.97 inch IPS
分辨率 Number of Pixels		320*480		480*800
驱动 Driver IC		ST7796		ST7701
显示区域 Active Area		48.96x73.44mm		51.84x86.40mm
模块尺寸 Module Size		57.26x96.52x5.48mm		56.44x106.95x3.63
颜色 Color		RGB		65K
接口 Interface		16-Bit 8080 MCU		4-SPI+16-Bit RGB
管脚 Pin		28		28
系统供电 System Voltage		3.3V		3.3V/5V 两种可选

尺寸 Size		4.0 inch TFT		4.0 inch TFT 电阻触摸
分辨率 Number of Pixels		320*480		320*480
驱动 Driver IC		ILI9488/ST7796		ILI9488/ST7796
显示区域 Active Area		55.68x83.52mm		55.68x83.52mm
模块尺寸 Module Size		61.88x106.57x3.7mm		61.88x106.57x5.2mm
颜色 Color		RGB		RGB
接口 Interface		4-SPI		4-SPI
管脚 Pin		8		11
系统供电 System Voltage		3.3V		3.3V

尺寸 Size		4.0 inch TFT		4.0 inch TFT 电阻触摸
分辨率 Number of Pixels		320*480		320*480
驱动 Driver IC		ILI9488		ILI9488
显示区域 Active Area		55.68x83.52mm		55.68x83.52mm
模块尺寸 Module Size		62x106.57x4.9mm		62x106.57x4.9mm
颜色 Color		RGB		RGB
接口 Interface		16-Bit 8080 MCU		16-Bit 8080 MCU
管脚 Pin		24		34
系统供电 System Voltage		3.3V		3.3V

TFT彩色模块 Full Color TFT Module

尺寸 Size		4.3 inch IPS		4.3 inch IPS 电阻触摸
分辨率 Number of Pixels		480*800		480*800
驱动 Driver IC		ST7265		ST7265
显示区域 Active Area		95.04x53.86mm		95.04x53.86mm
模块尺寸 Module Size		118.5x67.25x4.6mm		118.5x67.25x5.8mm
颜色 Color		16M		16M
接口 Interface		RGB888/666/555		RGB888/666/555
管脚 Pin		-----		-----
系统供电 System Voltage		3.3V		3.3V

尺寸 Size		4.3 inch IPS 电容触摸		5.0 inch IPS
分辨率 Number of Pixels		480*800		480*854
驱动 Driver IC		ST7265		ST7701S
显示区域 Active Area		95.04x53.86mm		61.63x109.65mm
模块尺寸 Module Size		118.5x67.25x5.8mm		68.56x134.35x3.97
颜色 Color		16M		6.5W
接口 Interface		RGB888/666/555		RGB888/666/565
管脚 Pin		-----		-----
系统供电 System Voltage		3.3V		3.3V



尺寸 Size		5.0 inch IPS 电容触摸		5.0 inch IPS
分辨率 Number of Pixels		480*854		480*800
驱动 Driver IC		ST7701S		ST7265
显示区域 Active Area		61.63x109.65mm		108x64.80mm
模块尺寸 Module Size		68.56x134.35x5.32		136.70x76.30x4.6
颜色 Color		6.5W		6.5W
接口 Interface		RGB888/666/565		RGB888/666/565
管脚 Pin		-----		-----
系统供电 System Voltage		3.3V		默认 5V

尺寸 Size		5.0 inch IPS 电容触摸	
分辨率 Number of Pixels		480*800	
驱动 Driver IC		ST7265	
显示区域 Active Area		108x64.80mm	
模块尺寸 Module Size		136.70x76.30x5.8	
颜色 Color		6.5W	
接口 Interface		RGB888/666/565	
管脚 Pin		-----	
系统供电 System Voltage		默认 5V	

墨水屏/电子纸模块 Electronic Paper Module



尺寸 Size		1.54 inch		1.54 inch
分辨率 Number of Pixels		152*152		152*152
驱动 Driver IC		SSD1680		SSD1680
显示区域 Active Area		27.51x27.51mm		27.51x27.51mm
模块尺寸 Module Size		32x50x2.5mm		32x50x2.5mm
颜色 Color		(White+Black)		(White+Black+Red)
接口 Interface		SPI		SPI
管脚 Pin		8		8
系统供电 System Voltage		3.3V		3.3V



尺寸 Size		1.54 inch		2.13 inch
分辨率 Number of Pixels		200*200		122*250
驱动 Driver IC		SSD1681		SSD1680
显示区域 Active Area		27.51x27.51mm		23.70x48.55mm
模块尺寸 Module Size		32x50x2.5mm		71.20x30x2.35mm
颜色 Color		(White+Black)		(White+Black)
接口 Interface		SPI		SPI
管脚 Pin		8		8
系统供电 System Voltage		3.3V		3.3V



尺寸 Size		2.13 inch		2.13 inch
分辨率 Number of Pixels		122*250		122*250
驱动 Driver IC		SSD1680		JD79661
显示区域 Active Area		23.70x48.55mm		23.70x48.55mm
模块尺寸 Module Size		71.20x30x2.35mm		71.20x30x2.35mm
颜色 Color		(White+Black+Red)		(W+B+R+Y)
接口 Interface		SPI		SPI
管脚 Pin		8		8
系统供电 System Voltage		3.3V		3.3V



尺寸 Size		2.66 inch		2.66 inch
分辨率 Number of Pixels		296*152		296*152
驱动 Driver IC		SSD1680		SSD1680
显示区域 Active Area		30.70x60.09mm		30.70x60.09mm
模块尺寸 Module Size		37x84x2.2mm		37x84x2.2mm
颜色 Color		(White+Black)		(White+Black+Red)
接口 Interface		SPI		SPI
管脚 Pin		8		8
系统供电 System Voltage		3.3V		3.3V

墨水屏/电子纸模块 Electronic Paper Module



尺寸 Size		2.66 inch		2.90 inch
分辨率 Number of Pixels		296*152		296*128
驱动 Driver IC		JD79661AA		SSD1680
显示区域 Active Area		30.70x60.09mm		29.06x66.90mm
模块尺寸 Module Size		37x84x2.2mm		37x91x2.35mm
颜色 Color		(W+B+R+Y)		(White+Black)
接口 Interface		SPI		SPI
管脚 Pin		8		8
系统供电 System Voltage		3.3V		3.3V



尺寸 Size		2.90 inch		3.7 inch
分辨率 Number of Pixels		296*128		240*416
驱动 Driver IC		SSD1680		UC8257
显示区域 Active Area		29.06x66.90mm		81.54x47.04mm
模块尺寸 Module Size		37x91x2.35mm		93.39x67x2.6mm
颜色 Color		(White+Black)		(White+Black)
接口 Interface		SPI		SPI
管脚 Pin		8		8
系统供电 System Voltage		3.3V		3.3V

尺寸 Size		3.7 inch		4.2 inch
分辨率 Number of Pixels		240*416		400*300
驱动 Driver IC		UC8257		SSD1683
显示区域 Active Area		81.54x47.04mm		84.8x63.6mm
模块尺寸 Module Size		93.39x67x2.6mm		91.50x90x2.4mm
颜色 Color		(White+Black+Red)		(White+Black)
接口 Interface		SPI		SPI
管脚 Pin		8		8
系统供电 System Voltage		3.3V		3.3V

尺寸 Size		4.2 inch		5.79 inch
分辨率 Number of Pixels		400*300		272*792
驱动 Driver IC		SSD1683		SSD1683x2
显示区域 Active Area		84.8x63.6mm		47.74x139mm
模块尺寸 Module Size		91.50x90x2.4mm		165x57.4x2.6mm
颜色 Color		(White+Black+Red)		(White+Black)
接口 Interface		SPI		SPI
管脚 Pin		8		8
系统供电 System Voltage		3.3V		3.3V

墨水屏 / 电子纸模块 Electronic Paper Module

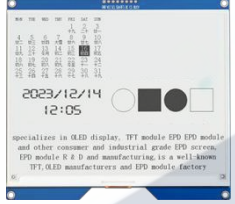
尺寸 Size		5.79 inch		5.79 inch
分辨率 Number of Pixels		272*792		272*792
驱动 Driver IC		SSD1683x2		HX8717x2
显示区域 Active Area		47.74x139mm		47.74x139mm
模块尺寸 Module Size		165x57.4x2.6mm		165x57.4x2.6mm
颜色 Color		(White+Black+Red)		(W+B+R+Y)
接口 Interface		SPI		SPI
管脚 Pin		8		8
系统供电 System Voltage		3.3V		3.3V

尺寸 Size		5.83 inch		5.83 inch
分辨率 Number of Pixels		648*480		648*480
驱动 Driver IC		UC8179		UC8179
显示区域 Active Area		118.78x88.22mm		118.78x88.22mm
模块尺寸 Module Size		126x114x2.8mm		126x114x2.8mm
颜色 Color		(White+Black)		(White+Black+Red)
接口 Interface		SPI		SPI
管脚 Pin		8		8
系统供电 System Voltage		3.3V		3.3V

尺寸 Size				
分辨率 Number of Pixels				
驱动 Driver IC				
显示区域 Active Area				
模块尺寸 Module Size				
颜色 Color				
接口 Interface				
管脚 Pin				
系统供电 System Voltage				

尺寸 Size				
分辨率 Number of Pixels				
驱动 Driver IC				
显示区域 Active Area				
模块尺寸 Module Size				
颜色 Color				
接口 Interface				
管脚 Pin				
系统供电 System Voltage				

Tai Ling Electronic Hardware Manufacturing Co., Ltd.



PRODUCT MANUAL